

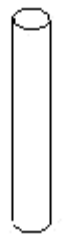











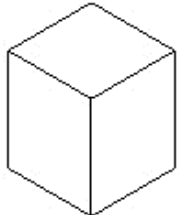
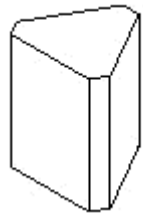

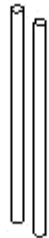
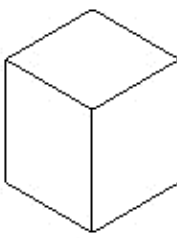
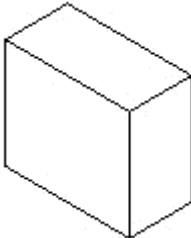
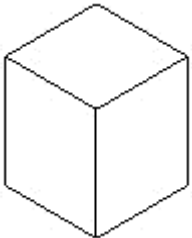

01 構造 > 意匠柱

				
AXi_角柱	AXi_丸柱	AXt_角柱	AXt_丸柱	

01 構造 > 基礎

				
AXt_S 杭_Pipe	AXt_フーチング_矩形	AXt_フーチング_ 正三角形	AXt_フーチング_ 直角三角形	AXt_既成杭_1 本
				
AXt_既成杭_2 本	AXt_杭基礎_既成杭 _1 本用	AXt_杭基礎_既成杭 _2 本用	AXt_杭基礎_場所打 RC	AXt_場所打 RC 杭







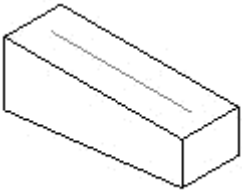
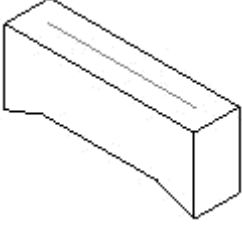
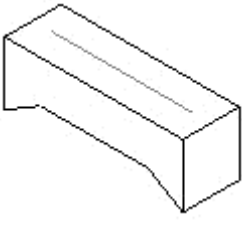
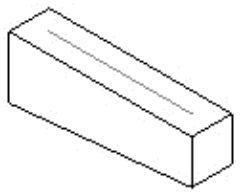
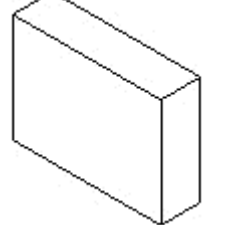
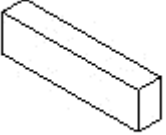
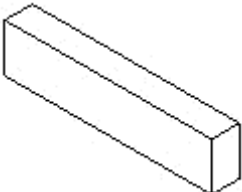
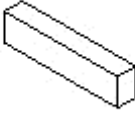
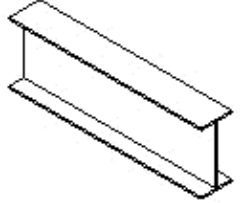
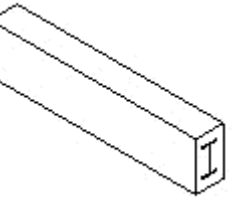

01 構造 > 柱

				
AXt_CFT_Box 柱	AXt_CFT_丸柱	AXt_RC 丸柱	AXt_RC 柱	AXt_S_Box 柱
				
AXt_S_H 柱	AXt_S_丸柱	AXt_SRC 柱		

AReX-Style Family Library 2022/2024

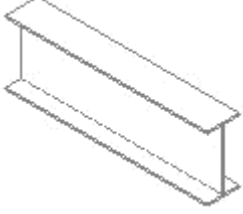
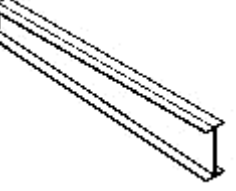
arex-style.com

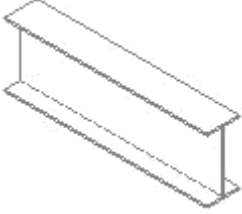
01 構造 > 梁

				
AXt_RC テーパー大梁	AXt_RC ハンチ付基礎梁	AXt_RC ハンチ付大梁	AXt_RC ハンチ付片持梁	AXt_RC 基礎梁
				
AXt_RC 小梁	AXt_RC 大梁	AXt_RC 片持梁	AXt_S_BH 梁	AXt_SRC 大梁
				
AXt_S テーパー梁	AXt_S ハンチ付梁	AXt_S 小梁	AXt_S 大梁	AXt_S 片持梁
				
AXt_ブレース	AXt_ブレース_H	AXt_ブレース_Pipe		

01 構造＞その他

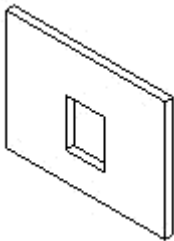









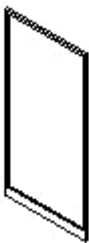
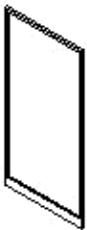

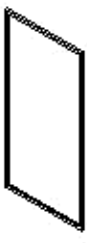

AXI_開口部

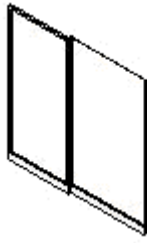
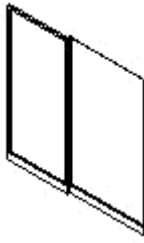
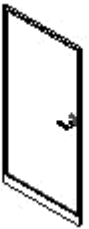
AReX-Style Family Library 2022/2024

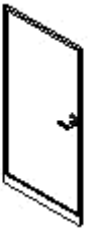
arex-style.com

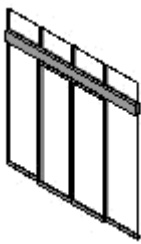
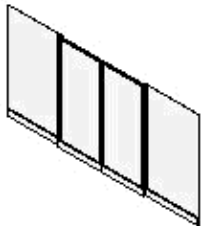
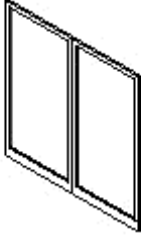
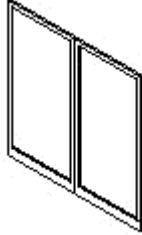
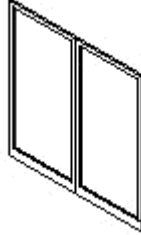
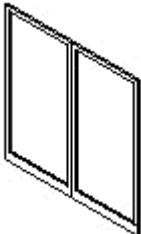
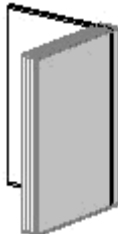



02 建具＞カーテンウォール

				
AX_CW たてすべり	AX_CW たてすべり窓	AX_CW はめ殺し	AX_CW はめ殺し窓	AX_CW 引違い
				
AX_CW 引違い窓	AX_CW 外倒し	AX_CW 外倒し窓	AX_CW 片引き	AX_CW 片引き戸
				
AX_CW 片開き	AX_CW 片開き扉	AX_CW 片自由開き	AX_CW 片自由開き扉	AX_CW 両引き
				
AX_CW 両引き オートドア+FIX	AX_CW 両引き戸	AX_CW 両開き	AX_CW 両開き扉	AX_CW 両自由開き
				
AX_CW 両自由開き扉	AX_SW パネル	AX_ガラス	AX_ガラリ	

AReX-Style Family Library 2022/2024

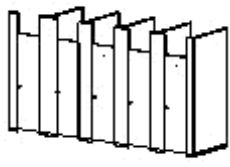
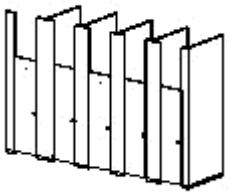
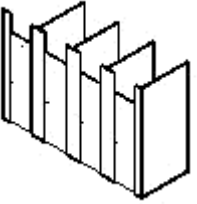
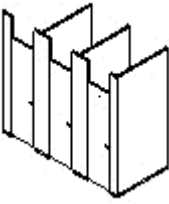
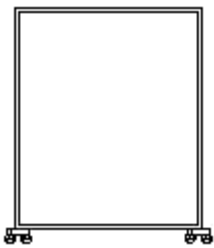
arex-style.com

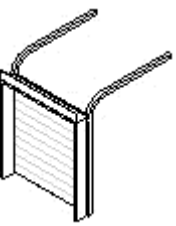
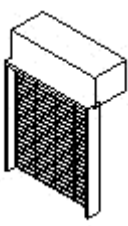
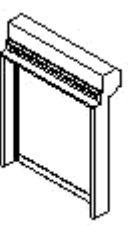
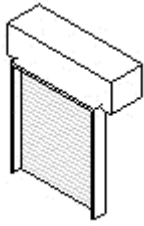
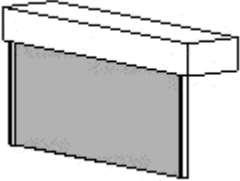
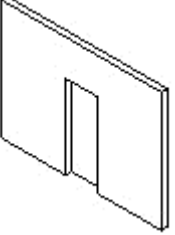
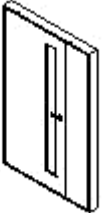
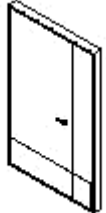
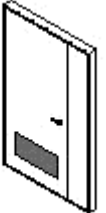

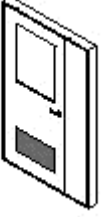
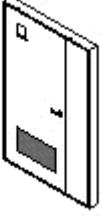
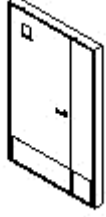
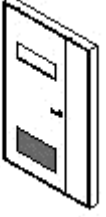







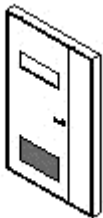

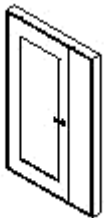
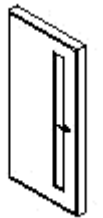
02 建具>ドア

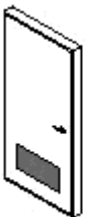
				
AX_トイレブース_SK +トイレ(右開き扉)	AX_トイレブース_SK +トイレ(左開き扉)	AX_トイレブース _トイレ(右開き扉)	AX_トイレブース _トイレ(左開き扉)	AX_パーティション
				
AX_パーティション _3連パネル	AXt_オーバースライ _ダー	AXt_グリルシャッター	AXt_シートシャッター	AXt_シャッター
				
AXt_リングシャッター	AXt_開口	AXt_外部親子開き扉 _スリット額入り	AXt_外部親子開き扉 _フラッシュ	AXt_外部親子開き扉 _フラッシュガラリ付
				
AXt_外部親子開き扉 _額入り	AXt_外部親子開き扉 _額入りガラリ付	AXt_外部親子開き扉 _小窓ガラリ付	AXt_外部親子開き扉 _小窓付	AXt_外部親子開き扉 _覗窓ガラリ付

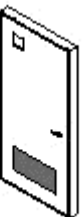
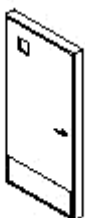
AReX-Style Family Library 2022/2024

arex-style.com



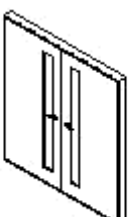
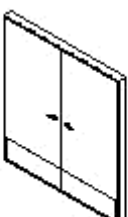
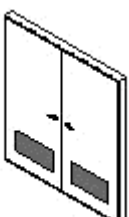
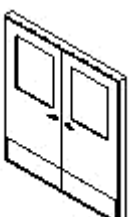



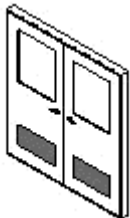
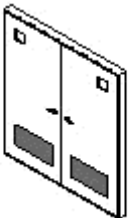
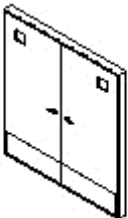

02 建具>ドア

				
AXt_外部親子開き扉 _視窓付	AXt_外部親子開き扉 _破壊用小窓ガラリ付	AXt_外部親子開き扉 _破壊用小窓付	AXt_外部親子開き扉 _框	AXt_外部片開き扉 _スリット額入り
				
AXt_外部片開き扉 _フラッシュ	AXt_外部片開き扉 _フラッシュガラリ付	AXt_外部片開き扉 _額入り	AXt_外部片開き扉 _額入りガラリ付	AXt_外部片開き扉 _小窓ガラリ付
				
AXt_外部片開き扉 _小窓付	AXt_外部片開き扉 _視窓ガラリ付	AXt_外部片開き扉 _視窓付	AXt_外部片開き扉 _破壊用小窓ガラリ付	AXt_外部片開き扉 _破壊用小窓付
				
AXt_外部片開き扉 _框	AXt_外部両開き扉 _スリット額入り	AXt_外部両開き扉 _フラッシュ	AXt_外部両開き扉 _フラッシュガラリ付	AXt_外部両開き扉 _額入り

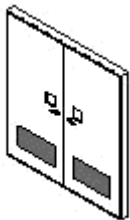
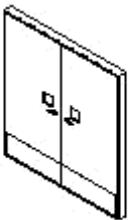
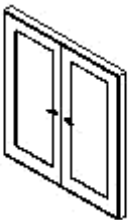
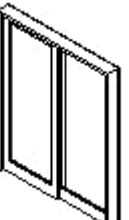
AReX-Style Family Library 2022/2024

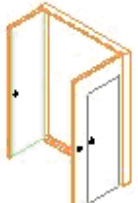
arex-style.com

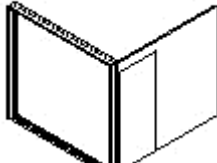
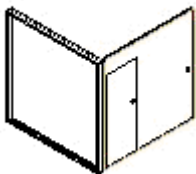
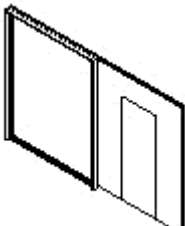
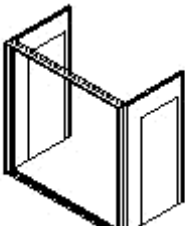

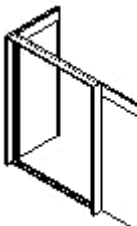
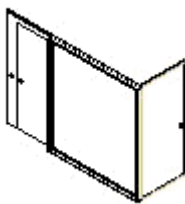







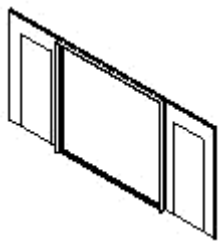
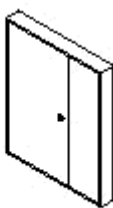

02 建具>ドア

				
AXt_外部両開き扉 _額入りガラリ付	AXt_外部両開き扉 _小窓ガラリ付	AXt_外部両開き扉 _小窓付	AXt_外部両開き扉 _視窓ガラリ付	AXt_外部両開き扉 _視窓付
				
AXt_外部両開き扉 _破壊用小窓ガラリ付	AXt_外部両開き扉 _破壊用小窓付	AXt_外部両開き扉 _框	AXt_自動ドア _片引き	AXt_自動ドア _両引分け
				
AXt_自由扉 +袖框 FIX	AXt_常開親子開き _90度	AXt_常開親子開き _90度_側壁埋込	AXt_常開片開_90度	AXt_常開片開_90度 _側壁埋込
				
AXt_常開片開 _180度	AXt_常開両開_90 _90度	AXt_常開両開_90 _90度_側壁埋込	AXt_常開両開_90 _180度	AXt_常開両開_90 _180度_側壁埋込





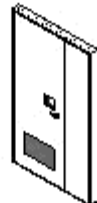
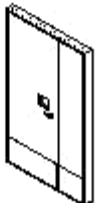

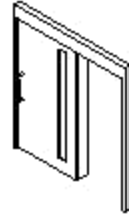
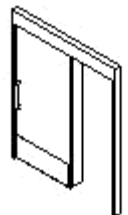
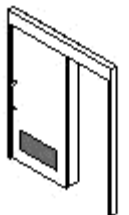
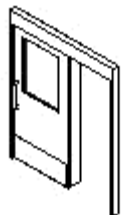
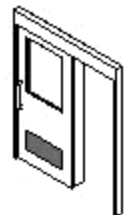
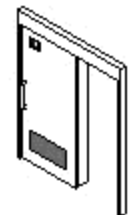



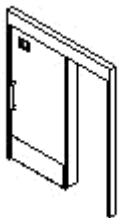
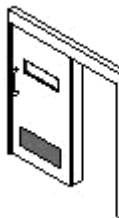
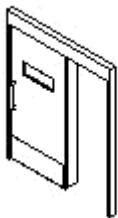
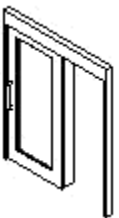
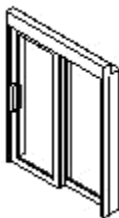
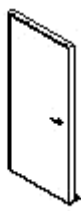

AReX-Style Family Library 2022/2024

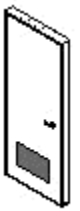
arex-style.com

02 建具>ドア

				
AXt_常開両開 _180_180度	AXt_親子開き点検扉	AXt_親子開き扉 _スリット額入り	AXt_親子開き扉 _フラッシュ	AXt_親子開き扉 _フラッシュガラリ付
				
AXt_親子開き扉 _額入り	AXt_親子開き扉 _額入りガラリ付	AXt_親子開き扉 _小窓ガラリ付	AXt_親子開き扉 _小窓付	AXt_親子開き扉 _覗窓ガラリ付
				
AXt_親子開き扉 _覗窓付	AXt_親子開き扉 _破壊用小窓ガラリ付	AXt_親子開き扉 _破壊用小窓付	AXt_親子開き扉_框	AXt_片引き戸 _スリット額入り
				
AXt_片引き戸 _フラッシュ	AXt_片引き戸 _フラッシュガラリ付	AXt_片引き戸 _額入り	AXt_片引き戸 _額入りガラリ付	AXt_片引き戸 _小窓ガラリ付

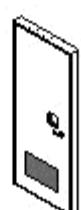

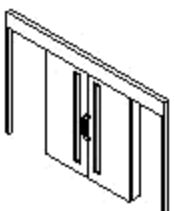



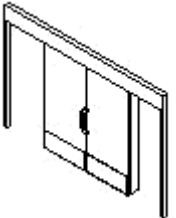
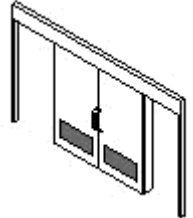
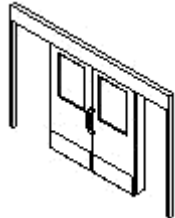
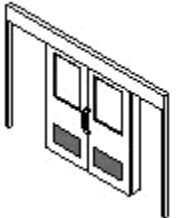
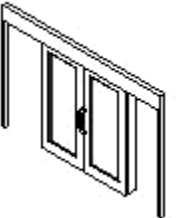
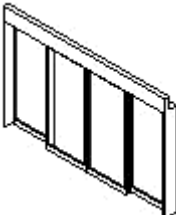
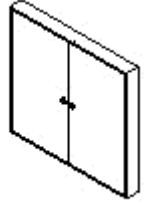
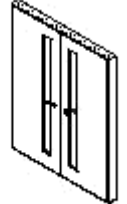
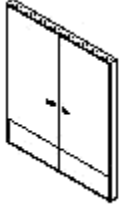
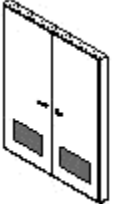

02 建具>ドア

				
AXt_片引き戸 _小窓付	AXt_片引き戸 _視窓ガラリ付	AXt_片引き戸 _視窓付	AXt_片引き戸_框	AXt_片引き戸_框 +袖框 FIX
				
AXt_片開き鋼製玄関 扉_フラッシュ	AXt_片開き点検扉	AXt_片開き扉 _スリット額入り	AXt_片開き扉 _フラッシュ	AXt_片開き扉 _フラッシュガラリ付
				
AXt_片開き扉_額入り	AXt_片開き扉 _額入りガラリ付	AXt_片開き扉 _小窓ガラリ付	AXt_片開き扉 _小窓付	AXt_片開き扉 _視窓ガラリ付
				
AXt_片開き扉 _視窓付	AXt_片開き扉 _破壊用小窓ガラリ付	AXt_片開き扉 _破壊用小窓付	AXt_片開き扉_框	AXt_両引き戸 _スリット額入り

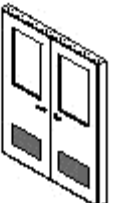
AReX-Style Family Library 2022/2024

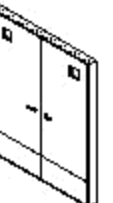
arex-style.com

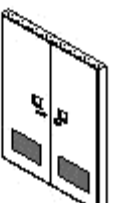
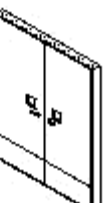
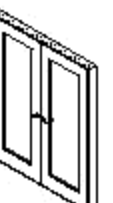





02 建具>ドア

				
AXt_両引き戸 _フラッシュ	AXt_両引き戸 _フラッシュガラリ付	AXt_両引き戸 _額入り	AXt_両引き戸 _額入りガラリ付	AXt_両引き戸 _框
				
AXt_両引き戸 _框+袖框 FIX	AXt_両開き点検扉	AXt_両開き扉 _スリット額入り	AXt_両開き扉 _フラッシュ	AXt_両開き扉 _フラッシュガラリ付
				
AXt_両開き扉_額入り	AXt_両開き扉 _額入りガラリ付	AXt_両開き扉 _小窓ガラリ付	AXt_両開き扉 _小窓付	AXt_両開き扉 _視窓ガラリ付
				
AXt_両開き扉 _視窓付	AXt_両開き扉 _破壊用小窓ガラリ付	AXt_両開き扉 _破壊用小窓付	AXt_両開き扉_框	AXt_枠_一方枠

AReX-Style Family Library 2022/2024

arex-style.com

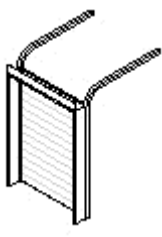
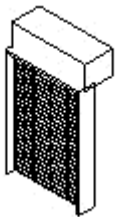
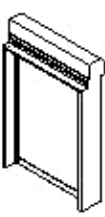
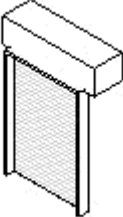
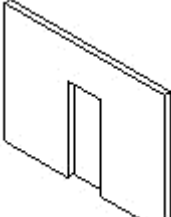
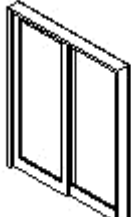
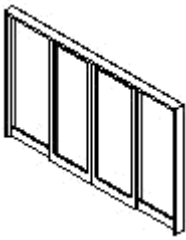

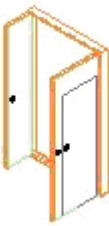
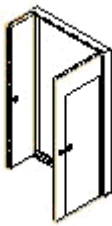
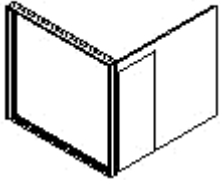
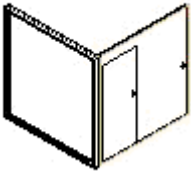
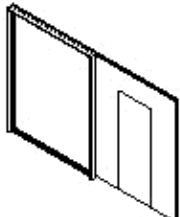
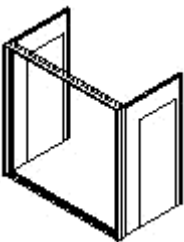
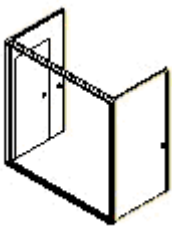
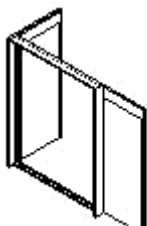
02 建具>ドア

				
AXt_枠_一方枠_上部	AXt_枠_三方枠	AXt_枠_二方枠	AXt_枠_二方枠_左右	AXi_オーバースライダー —
				
AXi_グリルシャッター	AXi_シートシャッター	AXi_シャッター	AXi_開口	AXi_自動ドア_片引き
				
AXi_自動ドア _両引分け	AXi_自由扉 +袖框 FIX	AXi_常開親子開き _90度	AXi_常開親子開き _90度_側壁埋込	AXi_常開片開_90度
				
AXi_常開片開_90度 _側壁埋込	AXi_常開片開 _180度	AXi_常開両開_90 _90度	AXi_常開両開_90 _90度_側壁埋込	AXi_常開両開 _90_180度

AReX-Style Family Library 2022/2024

arex-style.com

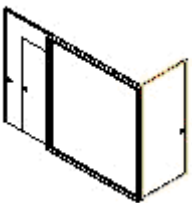
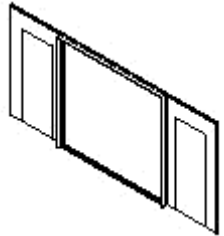
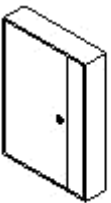
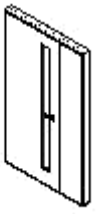
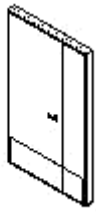
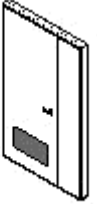

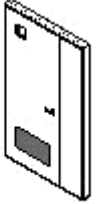
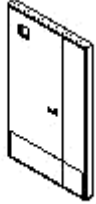
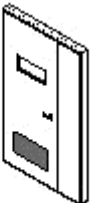
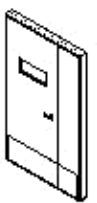
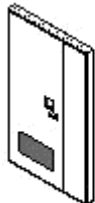
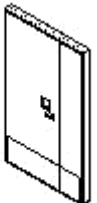
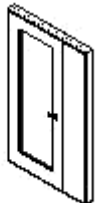
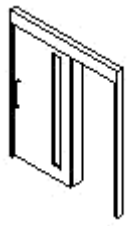
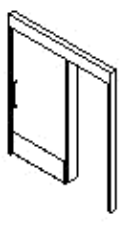
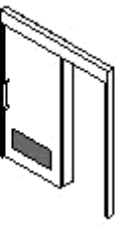
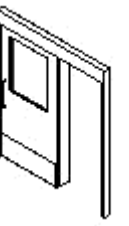
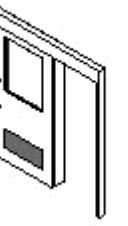







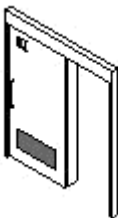
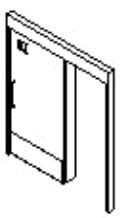
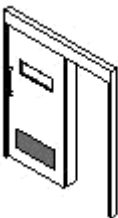
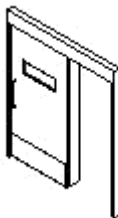
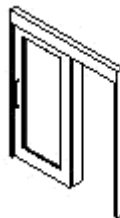
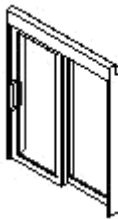
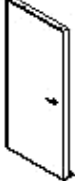
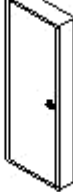

02 建具>ドア

				
AXi_常開両開_90 _180度_側壁埋込	AXi_常開両開 _180_180度	AXi_親子開き点検扉	AXi_親子開き扉 _スリット額入り	AXi_親子開き扉 _フラッシュ
				
AXi_親子開き扉 _フラッシュガラリ付	AXi_親子開き扉 _額入り	AXi_親子開き扉 _額入りガラリ付	AXi_親子開き扉 _小窓ガラリ付	AXi_親子開き扉 _小窓付
				
AXi_親子開き扉 _視窓ガラリ付	AXi_親子開き扉 _視窓付	AXi_親子開き扉 _破壊用小窓ガラリ付	AXi_親子開き扉 _破壊用小窓付	AXi_親子開き扉_框
				
AXi_片引き戸 _スリット額入り	AXi_片引き戸 _フラッシュ	AXi_片引き戸 _フラッシュガラリ付	AXi_片引き戸_額入り	AXi_片引き戸 _額入りガラリ付





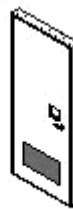



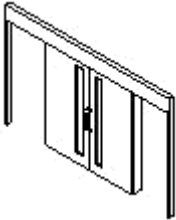
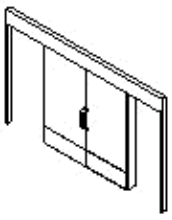
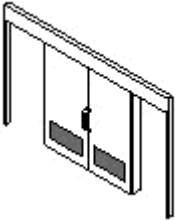
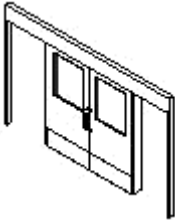
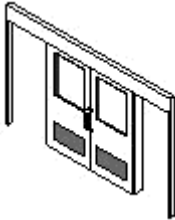
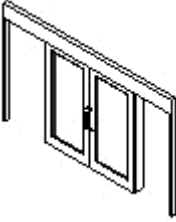
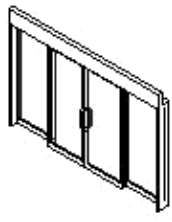
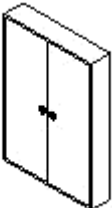

AReX-Style Family Library 2022/2024

arex-style.com



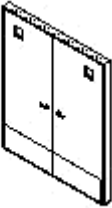

02 建具>ドア

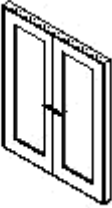
				
AXi_片引き戸 _小窓ガラリ付	AXi_片引き戸 _小窓付	AXi_片引き戸 _視窓ガラリ付	AXi_片引き戸_視窓付	AXi_片引き戸_框
				
AXi_片引き戸 _框+袖框 FIX	AXi_片開き鋼製 玄関扉_フラッシュ	AXi_片開き点検扉	AXi_片開き扉 _スリット額入り	AXi_片開き扉 _フラッシュ
				
AXi_片開き扉 _フラッシュガラリ付	AXi_片開き扉_額入り	AXi_片開き扉 _額入りガラリ付	AXi_片開き扉 _小窓ガラリ付	AXi_片開き扉 _小窓付
				
AXi_片開き扉 _視窓ガラリ付	AXi_片開き扉 _視窓付	AXi_片開き扉 _破壊用小窓ガラリ付	AXi_片開き扉 _破壊用小窓付	AXi_片開き扉_框

02 建具>ドア

				
AXi_両引き戸 _スリット額入り	AXi_両引き戸 _フラッシュ	AXi_両引き戸 _フラッシュガラリ付	AXi_両引き戸_額入り	AXi_両引き戸 _額入りガラリ付
				
AXi_両引き戸_框	AXi_両引き戸 _框+袖框 FIX	AXi_両開き点検扉	AXi_両開き扉 _スリット額入り	AXi_両開き扉 _フラッシュ
				
AXi_両開き扉 _フラッシュガラリ付	AXi_両開き扉_額入り	AXi_両開き扉 _額入りガラリ付	AXi_両開き扉 _小窓ガラリ付	AXi_両開き扉_小窓付
				
AXi_両開き扉 _視窓ガラリ付	AXi_両開き扉 _視窓付	AXi_両開き扉 _破壊用小窓ガラリ付	AXi_両開き扉 _破壊用小窓付	AXi_両開き扉_框



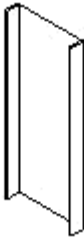







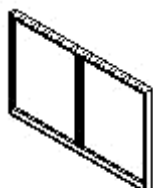
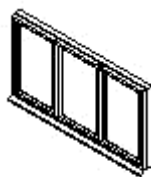
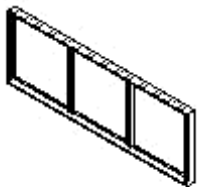
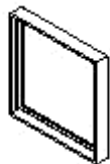

02 建具>ドア

				
AXi_枠_一方枠	AXi_枠_一方枠_上部	AXi_枠_三方枠	AXi_枠_二方枠	AXi_枠_二方枠_左右

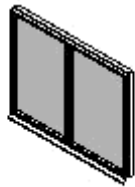
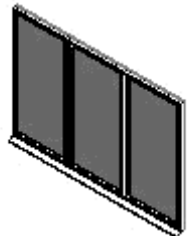
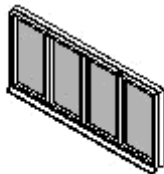
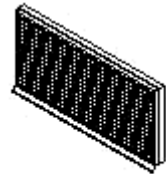
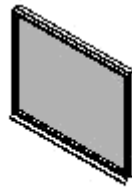
AReX-Style Family Library 2022/2024

arex-style.com











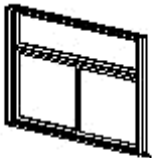

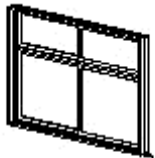

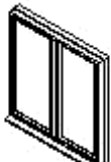
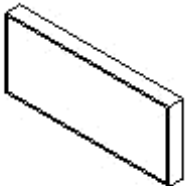
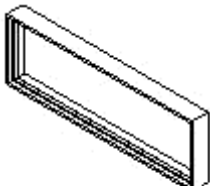
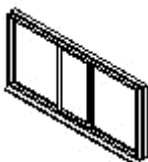

02 建具＞窓

				
AXt_2段1列	AXt_FIX窓	AXt_FIX窓_2連	AXt_FIX窓_2連_内部	AXt_FIX窓_n連
				
AXt_FIX窓_n連_内部	AXt_FIX窓_内部	AXt_FIX窓+上部FIX窓	AXt_FIX窓+上部ガラリ	AXt_ガラスブロック
				
AXt_ガラリ_1段2列	AXt_ガラリ_1段3列	AXt_ガラリ_1段n列	AXt_ガラリ_羽表現	AXt_ガラリ_屋外用
				
AXt_すべり出し窓	AXt_たてすべり出し窓	AXt_たて軸回転窓	AXt_引違い四本引	AXt_引違い窓

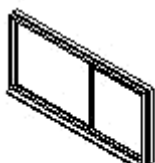
AReX-Style Family Library 2022/2024

arex-style.com

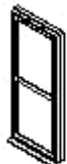

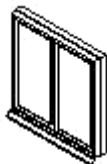



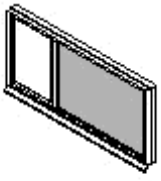

02 建具＞窓

				
AXt_引違い窓 +上部FIX窓	AXt_引違い窓 +上部ガラリ	AXt_引違い窓 +上部引違い窓	AXt_横軸回転窓	AXt_外倒し +Fix窓
				
AXt_外倒し窓	AXt_外倒し排煙窓 _2連	AXt_四方枠	AXt_四方枠 _パネル無し	AXt_自由片引き窓
				
AXt_上げ下げ窓	AXt_突き出し窓	AXt_内倒し窓	AXt_片引き窓	AXt_片引き窓 +上部FIX窓
				
AXt_片引き窓 +上部ガラリ	AXt_片開き窓	AXt_片開き枠窓	AXt_片上げ下げ窓	AXt_両開き窓

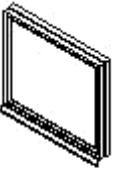

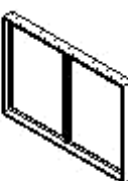
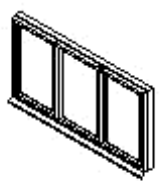
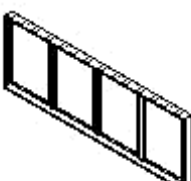
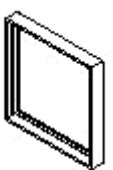
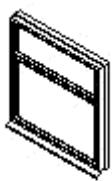
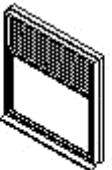

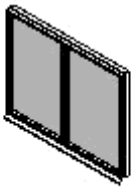
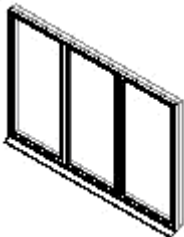
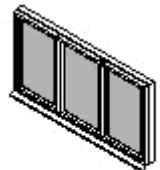
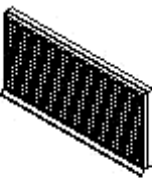
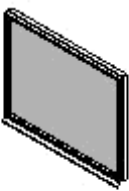
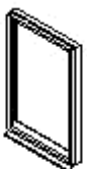





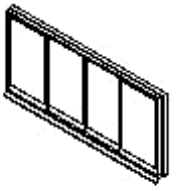
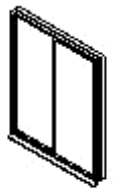

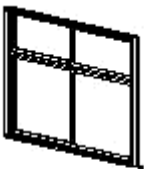
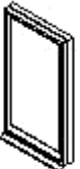
AReX-Style Family Library 2022/2024

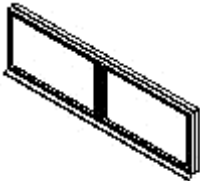
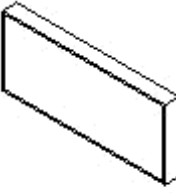
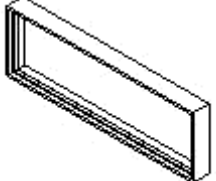
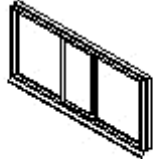
arex-style.com

02 建具＞窓

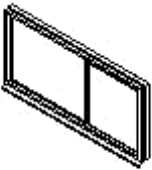
				
AXt_両袖片引き窓	AXt_嵌殺し+ガラリ	AXi_2段1列	AXi_FIX窓	AXi_FIX窓_2連
				
AXi_FIX窓_2連_内部	AXi_FIX窓_n連	AXi_FIX窓_n連_内部	AXi_FIX窓_内部	AXi_FIX窓 +上部FIX窓
				
AXi_FIX窓 +上部ガラリ	AXi_ガラスブロック	AXi_ガラリ _1段2列	AXi_ガラリ _1段3列	AXi_ガラリ _1段n列
				
AXi_ガラリ_羽表現	AXi_ガラリ_屋外用	AXi_すべり出し窓	AXi_たてすべり出し窓	AXi_たて軸回転窓

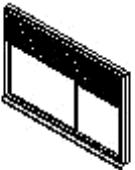
02 建具＞窓

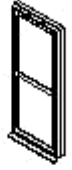
				
AXi_引違い四本引	AXi_引違い窓	AXi_引違い窓 +上部 FIX 窓	AXi_引違い窓 +上部ガラリ	AXi_引違い窓 +上部引違い窓
				
AXi_横軸回転窓	AXi_外倒し+Fix 窓	AXi_外倒し窓	AXi_外倒し排煙窓 _2 連	AXi_四方枠
				
AXi_四方枠 _パネル無し	AXi_自由片引き窓	AXi_上げ下げ窓	AXi_突き出し窓	AXi_内倒し窓
				
AXi_片引き窓	AXi_片引き窓 +上部 FIX 窓	AXi_片引き窓 +上部ガラリ	AXi_片開き窓	AXi_片開き框窓

02 建具＞窓

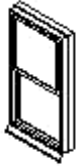

AXi_片上げ下げ窓

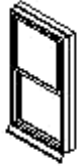

AXi_両開き窓

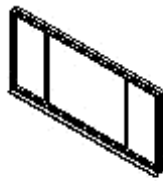



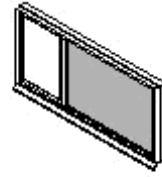

AXi_両袖片引き窓



AXi_嵌殺し+ガラリ

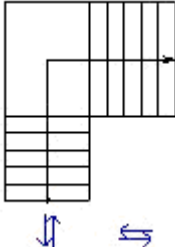
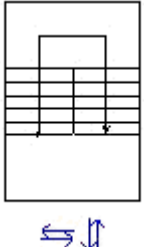
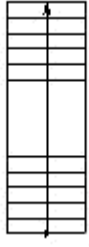
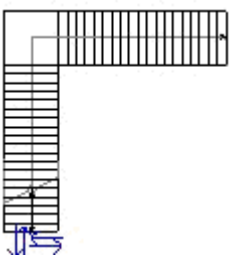

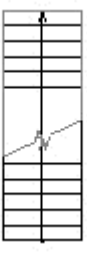





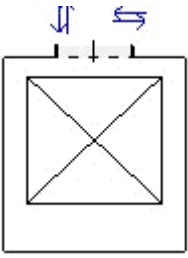
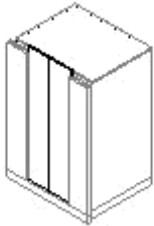

03 階段・手すり

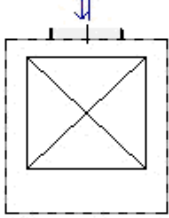
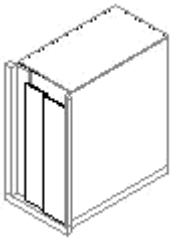
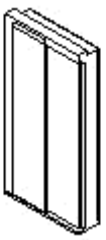
				
<p>AX_ノンスリップ 1</p>	<p>AX_ノンスリップ 2</p>	<p>AXi_かね折れ階段_2D</p>	<p>AXi_折り返し階段_2D</p>	<p>AXi_直階段_2D</p>
				
<p>AXi2_かね折れ階段</p>	<p>AXi2_折り返し階段</p>	<p>AXi2_直階段</p>		

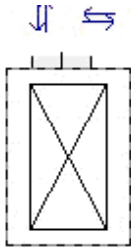
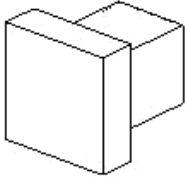
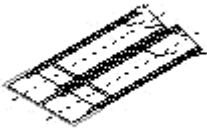

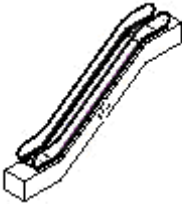

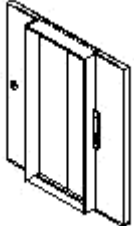
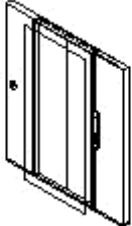

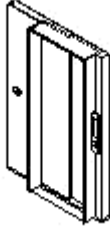
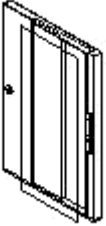



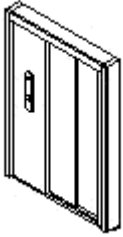
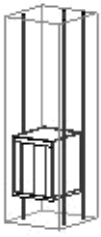

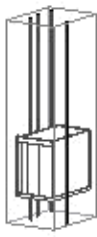
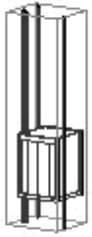
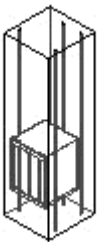
AReX-Style Family Library 2022/2024

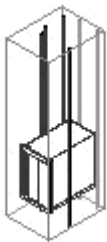
arex-style.com

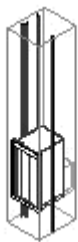
04 設備 > 搬送機器

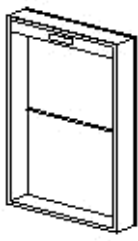
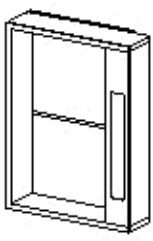
				
AXt_乗用 EV	AX_乗用 EV3D	AX_乗用 EV2D_大枠	AX_乗用 EV2D_小枠	AX_乗用 EV_2D
				
AX_住宅用 EV3D	AX_住宅用 EV2D_大枠	AX_住宅用 EV2D_小枠	AX_住宅用 EV_2D	AX_自火報用点検口
				
AX_エスカレーター2 台_2D	AX_エスカレーター1 台_2D	AX_エスカレーター _3D	AX_エスカレーター _2D	AX_EV_両引き戸_幕 板付
				
AX_EV_両引き戸_大 枠	AX_EV_両引き戸_小 枠	AX_EV_片引き戸_幕 板付	AX_EV_片引き戸_大 枠	AX_EV_片引き戸_小 枠

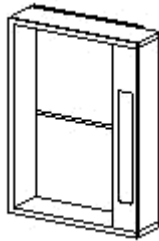

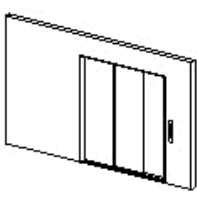
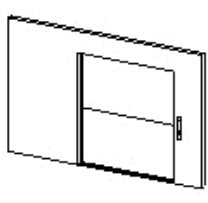
04 設備 > 搬送機器

				
AX_EV_片引き戸_パネル付	AX_EV_非常用_両引き戸	AX_EV_寝台用_片引き戸_2方向	AX_EV_寝台用_片引き戸	AX_EV_乗用_両引き戸_2方向
				
AX_EV_乗用_両引き戸	AX_EV_乗用_片引き戸_2方向	AX_EV_乗用_片引き戸	AX_EV_住宅用_片引き戸_2方向	AX_EV_住宅用_片引き戸
				
AX_EV_荷物用	AX_EV_ダムウェーター扉_フロアタイプ	AX_EV_ダムウェーター扉_テーブルタイプ	AX_EV_ダムウェーター扉_フロアタイプ扉	AX_EV_ダムウェーター扉_テーブルタイプ扉
				
AX_EV_ダムウェーター	AX_EV_3枚片引き戸_大枠	AX_EV_2枚上引き戸_小枠		

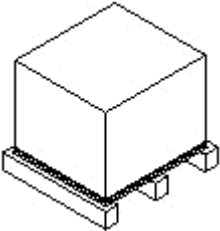
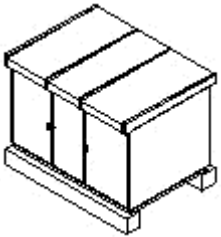
04 設備 > 特殊設備

				
AX_受水槽	AX_連結送水管ブ スターポンプ			

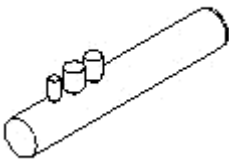
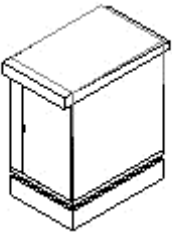
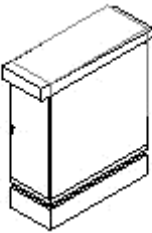
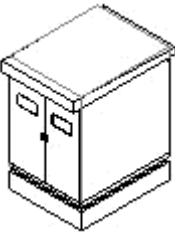
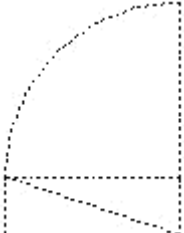
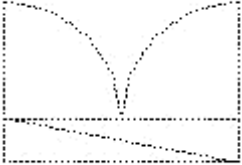
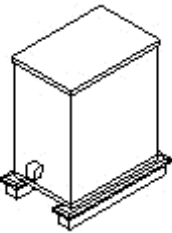
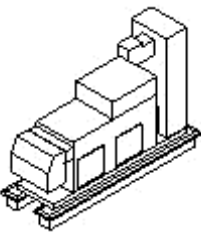







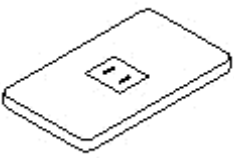
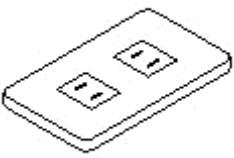
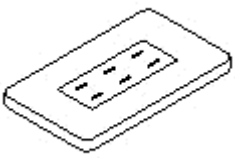

04 設備 > 電気設備

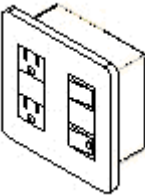
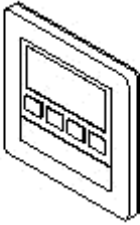
				
AX_オイルタンク	AX_キュービクル_親 子開き扉	AX_キュービクル_片 開き扉	AX_キュービクル_両 開き扉	AX_電気設備_片開き
				
AX_電気設備_両開き	AX_燃料タンク	AX_発電機	AX_分電盤	

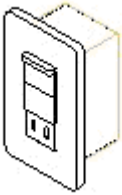
AReX-Style Family Library 2022/2024

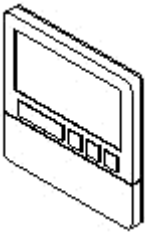
arex-style.com

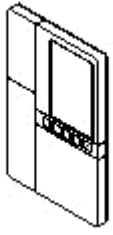
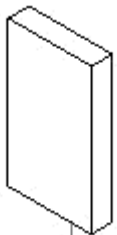
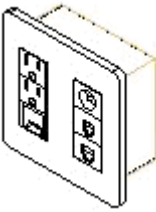
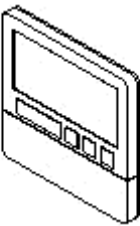
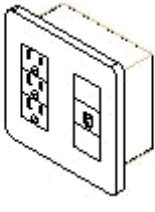
04 設備 > 電気器具

				
AX_IH用コンセント	AX_MEP_1socket	AX_MEP_2socket	AX_MEP_3socket	AX_エアコン用コンセント
				
AX_スイッチ_2連+コンセント_2コ	AX_バス乾燥機コントローラー	AX_バス暖リモコン	AX_フットライト+コンセント	AX_レンジフード用コンセント
				
AX_給湯器用リモコン	AX_給湯器用防水コンセント	AX_住宅情報盤用コンセント	AX_床暖房コントローラー	AX_床暖房リモコン
				
AX_情報コンセント_コンセント+TV+TEL+LAN	AX_台所リモコン	AX_電話コンセント_コンセント+TEL	AX_防水コンセント	AX_埋込コンセント







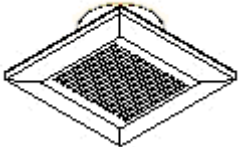





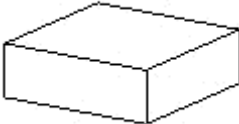

04 設備 > 通信機器

				
AX_インターホン親機ト	AX_スピーカー	AX_ドアホン	AX_端子盤	





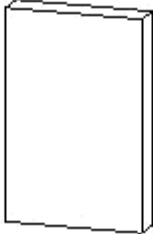
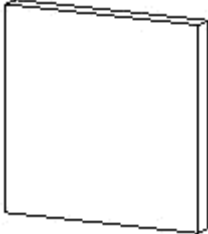
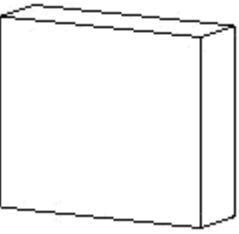
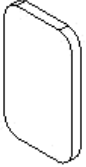

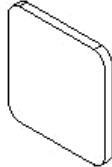
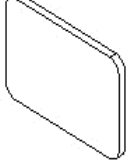
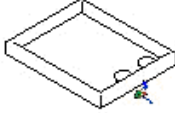





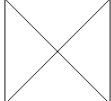

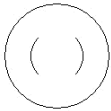

04 設備 > 制気口

				
AX_副吸込み口				

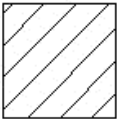
04 設備 > 設備

				
AX_コールボタン	AX_コントロールボックス	AX_ジャンクションボックス	AX_プルボックス	AX_モニタ付住宅情報盤
				
AX_レンジファン用埋込コンセント	AX_ワイド型スイッチ	AX_ワイド型スイッチ 2連	AX_引掛埋込ローゼット	AX_感知器
				
AX_給気ダンパー	AX_蛍光灯(天井付)	AX_戸外表示器	AX_弱電機器取付板	AX_分電盤
				
AX_壁付コンセント	AX_埋込コンセント	AX_埋込コンセント 2連	AX_埋込コンセント 3連	AX_洗濯機パン





04 設備 > 設備

				
AX2_コールボタン	AX2_コントロールボックス	AX2_ジャンクションボックス	AX2_プルボックス	AX2_モニタ付住宅情報盤
				
AX2_レンジファン用埋込コンセント	AX2_ワイド型スイッチ	AX2_ワイド型スイッチ 2 連	AX2_引掛埋込ローゼット	AX2_感知器
				
AX2_給気ダンパー	AX2_蛍光灯(天井付)	AX2_戸外表示器	AX2_弱電機器取付板	AX2_分電盤
				
AX2_壁付コンセント	AX2_埋込コンセント	AX2_埋込コンセント 2 連	AX2_埋込コンセント 3 連	











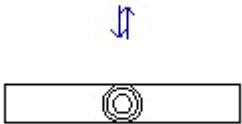

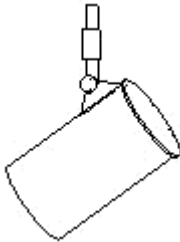
AReX-Style Family Library 2022/2024

arex-style.com

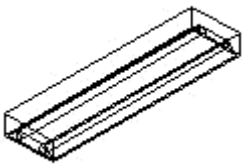

04 設備 > 照明装置

				
AX_スイッチ_1連	AX_スイッチ_2連	AX_スイッチ_3連	AX_熱線センサー式スイッチ	

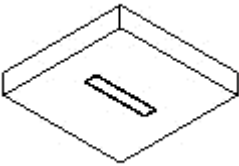
04 設備 > 照明器具

				
AX_LEDライト	AX_LEDライト_洗面化粧台用	AX_LED間接照明	AX_スポットライト	AX_ダウンライト
				
AX_ポーチライト1	AX_ポールライト1_円柱	AX_ポールライト2_角柱	AX_ライティンググレー	AX_引掛けシーリング
				
AX_街灯1	AX_蛍光灯	AX_照明_屋外庭園灯	AX_病室照明器具FL	

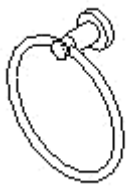
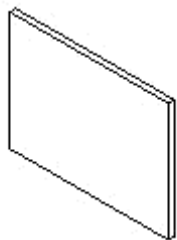
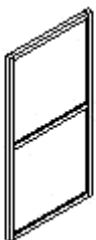
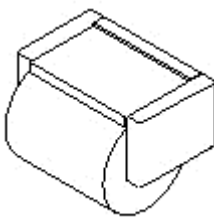
04 設備 > 住宅設備

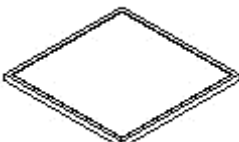
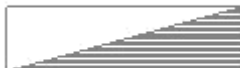
				
AX_タオルリング	AX_タオル掛け	AX_バルコニー隔板	AX_ペーパーホルダ —	AX_手摺付き物干し
				
AX_洗濯機パン	AX_避難ハッチ	AX_分電盤		

04 設備 > 機械設備

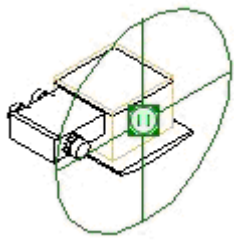
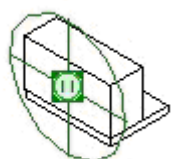
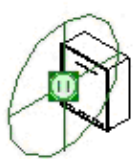
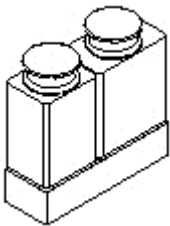
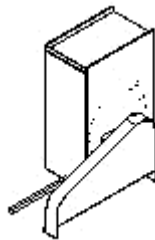
				
AX_ミスト付浴室暖房 乾燥機	AX_換気扇	AX_給湯暖房熱源機	AX_室外機_冷暖同時 ビル用マルチ	AX_排煙用送風機_床 置き型



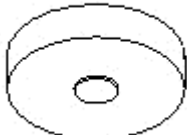
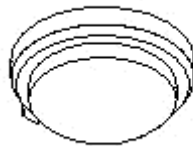
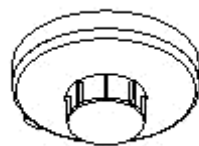
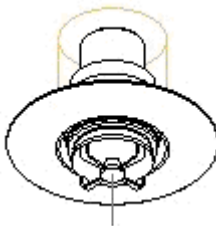
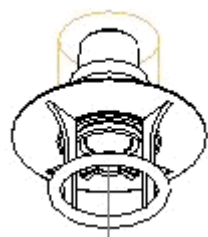
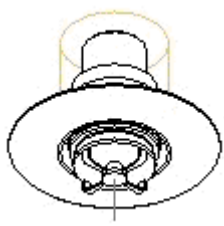







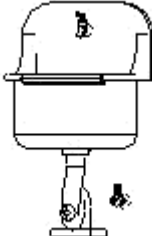
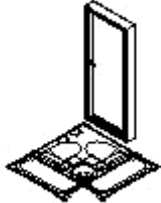
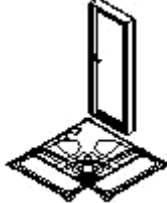
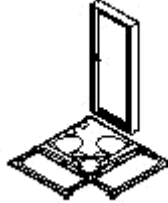

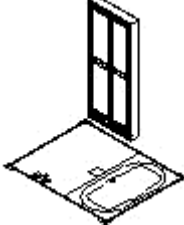

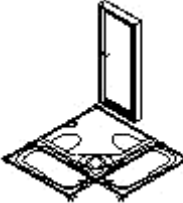
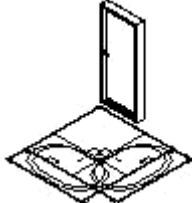

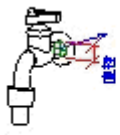
04 設備 > 火災報知器

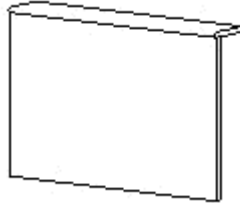
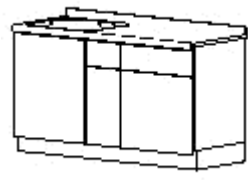
				
AX_ガス検知器	AX_差動式スポット型 感知器	AX_低温式スポット型 感知器	AX_閉鎖型 SP ヘッド 72 度	AX_閉鎖型 SP ヘッド 72 度_保護網付
				
AX_閉鎖型 SP ヘッド 96 度				

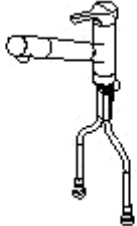
AReX-Style Family Library 2022/2024

arex-style.com

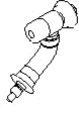
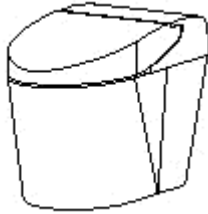
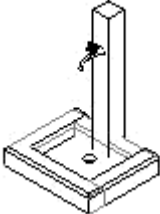

04 設備 > 衛生器具

				
AX_SK	AX_UB1014_3 点式	AX_UB1115_3 点式	AX_UB1116_3 点式	AX_UB1218_3 点式
				
AX_UB1418	AX_UB1418_3 点式	AX_UB1420_3 点式	AX_UB1620	AX_ガスコック
				
AX_キー式散水栓 1	AX_キー式散水栓 2	AX_キー式散水栓 3	AX_ライニング	AX_給湯室シンク
				
AX_混合水栓_1	AX_混合水栓_2	AX_混合水栓_洗面化粧台	AX_止水栓	AX_紙巻器
				
AX_小便器	AX_水道メーター	AX_洗濯機用単水栓	AX_大便器	AX_地流し





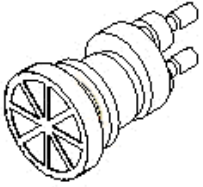



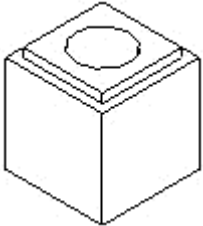
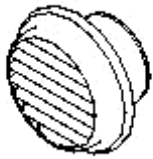

AReX-Style Family Library 2022/2024

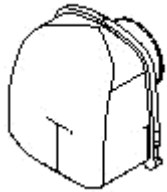
arex-style.com

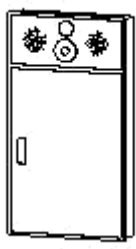
04 設備 > 衛生器具

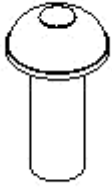
				
AX_追い炊き循環金具	AX_立水栓			

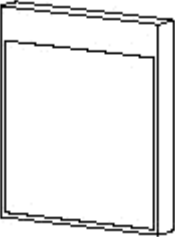

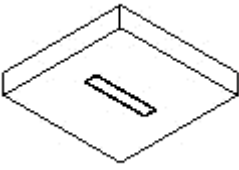
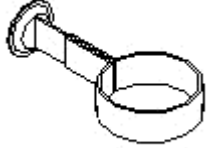



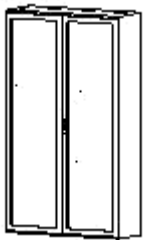
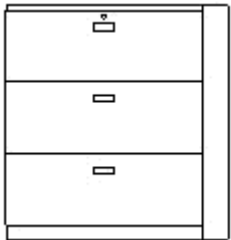

04 設備 > その他

				
AX_ハンドホール	AX_ベントキャップ	AX_ベントキャップ_丸形フード付	AX_ベントキャップ_深形フード付	AX_屋内消火栓設備
				
AX_屋内消火栓設備_埋込型	AX_視覚障害者誘導用タイル_線状	AX_視覚障害者誘導用タイル_点状	AX_床下換気口	AX_水道メーター
				
AX_通路誘導灯	AX_排水目皿	AX_避難口誘導灯 1	AX_避難口誘導灯 2	AX_樋持金物

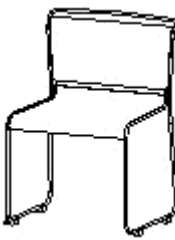
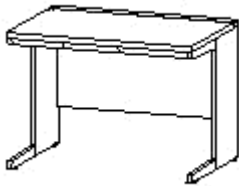
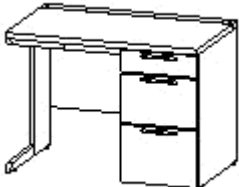

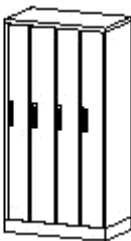

AReX-Style Family Library 2022/2024

arex-style.com

05 家具>オフィス用

				
AX_オフィス用キャビネット_ガラス両開き扉型	AX_オフィス用キャビネット_引出し型	AX_オフィス用キャビネット_両開き扉型	AX_オフィス用スタンディングチェア	AX_オフィス用デスク
				
AX_オフィス用デスク_片袖	AX_オフィス用ハイバックチェア	AX_ロッカー1	AX_ロッカー2	AX_会議室用テーブル_1
				
AX_会議室用テーブル_2				

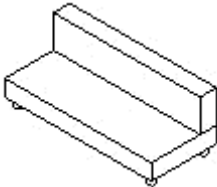
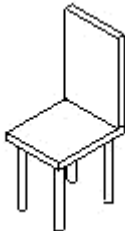
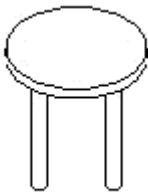
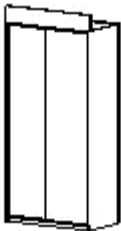
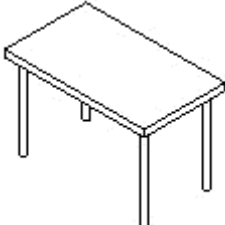
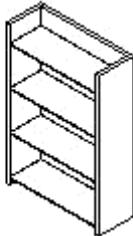
05 家具＞住宅用

				
AX_WIC 棚板	AX_クローゼット棚板	AX_ソファ	AX_椅子 1	AX_椅子 2
				
AX_引戸収納家具	AX_机	AX_棚	AX_物入棚	



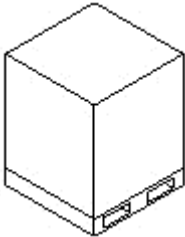
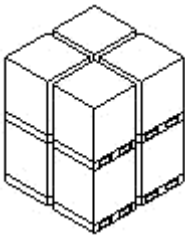
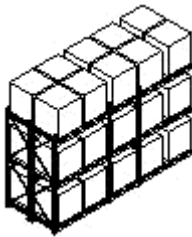
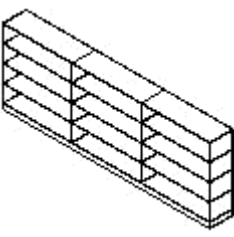



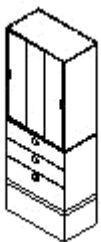
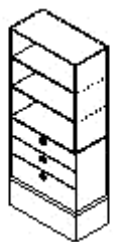

05 家具＞倉庫用

				
AX_パレット(荷持付)	AX_パレット_複数	AX_パレット収納ラック 置き	AX_棚 H1800	

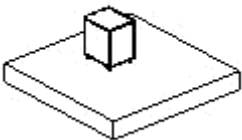
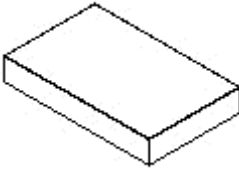
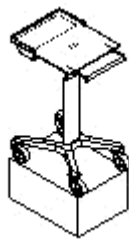
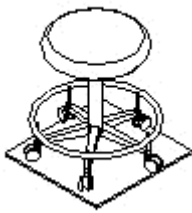
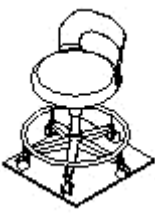

AReX-Style Family Library 2022/2024

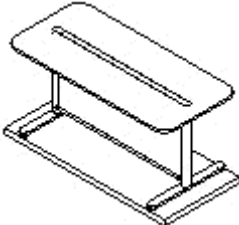
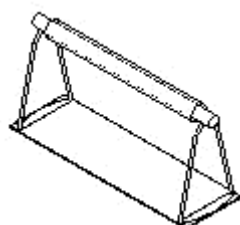
arex-style.com

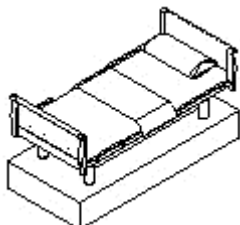
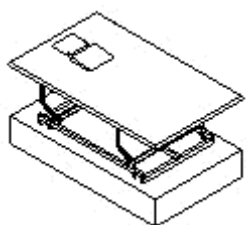
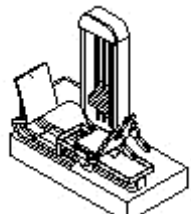
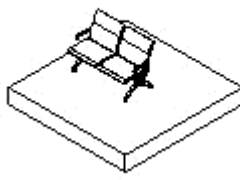
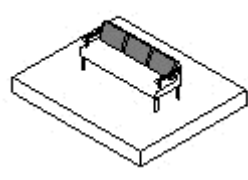
05 家具＞病院用

				
AX_3段_上3枚引違い書庫	AX_3段_上キャビネット	AX_Bike	AX_Run	AX_カルテ棚
				
AX_オフィス用デスク_片袖	AX_サイド収納付ワゴン	AX_トレーニングマット	AX_ナースカート	AX_ナースツール背なし
				
AX_ナースツール背付	AX_ナースチェアー	AX_ナーステーブル	AX_ハイシードベンチ	AX_バランスボール
				
AX_ヘルスケアベット	AX_ホバーステーブル	AX_レッグプレスマシン	AX_ロビーチェアー1	AX_ロビーチェアー2

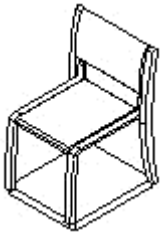
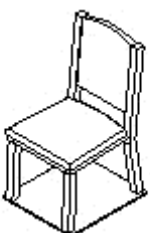
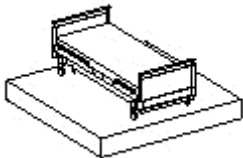
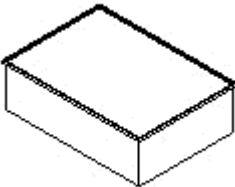
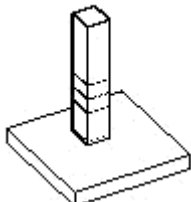
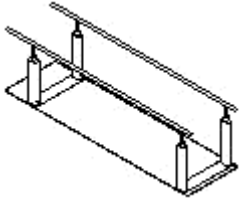
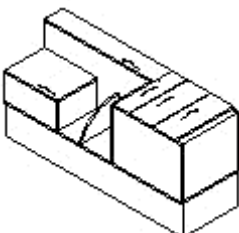
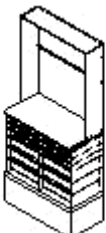
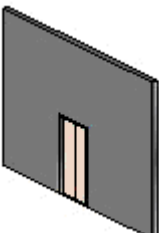
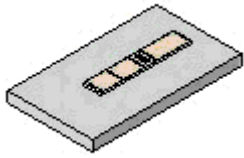
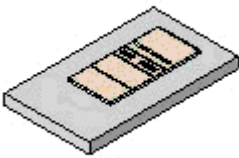
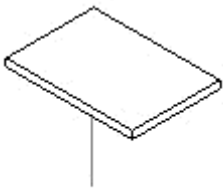

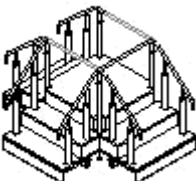
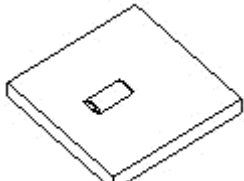







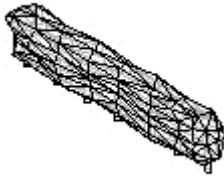
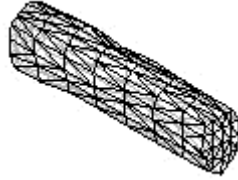

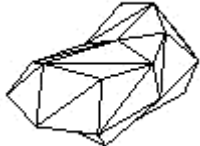

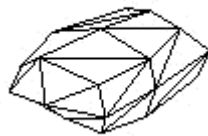

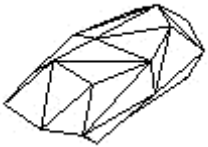



05 家具＞病院用

				
AX_椅子 3	AX_椅子 4	AX_医療用ベッド	AX_絵	AX_収納ユニット
				
AX_昇降式平行棒	AX_棚 600W	AX_調剤トレー棚	AX_病室折戸	AX_病室壁面パネル
				
AX_病室壁面パネル_ダブル	AX_病室用カーテンレール	AX_歩行器	AX_歩行訓練用階段	AX_枕

AReX-Style Family Library 2022/2024

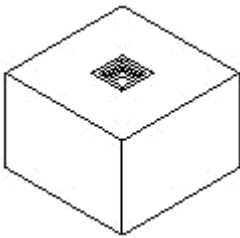
arex-style.com



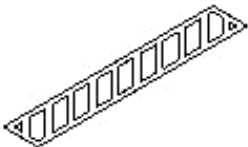







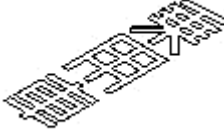
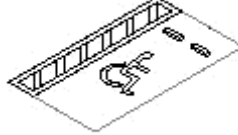

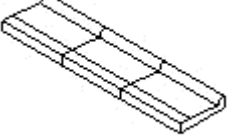
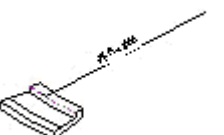
06 外構・点景＞外構

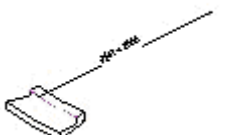
				
AX_LTree01_M	AX_LTree02_S	AX_LTree03_S	AX_LTree04_S	AX_Stone_01
				
AX_Stone_02	AX_Stone_03	AX_Stone_04	AX_Stone_05	AX_Tree01_M
				
AX_Tree02_L	AX_Tree03_M	AX_Tree04_M	AX_Tree05_S	AX_Tree06_M
				
AX_Tree07_S	AX_Tree08_S	AX_Tree09_S	AX_Tree10_M	AX_U形用集水ます
				
AX_U形用集水ます ふた_グレーチング	AX_U形用集水ます ふた_装鉄製	AX_カーブミラー(独 立型)	AX_カーブミラー	AX_ゼブラマーク

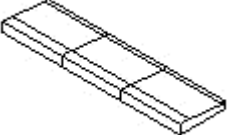
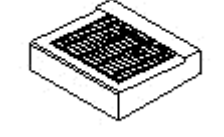
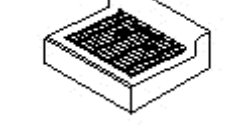

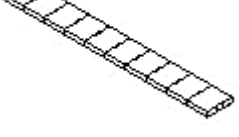
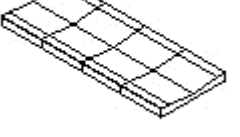

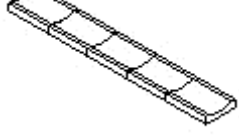

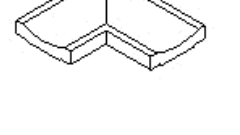



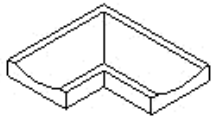

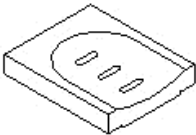
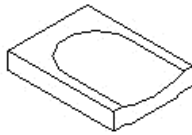
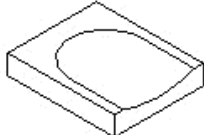
06 外構・点景＞外構

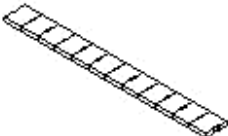
AX_ターンテーブル	AX_パーキングブロック_コンクリート	AX_フェンス扉(片開き)	AX_フェンス扉(両開き)	AX_汚水ます(円形)一般
AX_汚水ます(円形)一般 500用	AX_汚水ます(円形)一般 700用	AX_汚水ますふた(円形コンクリート)一般	AX_汚水ますふた(円形鉄)一般	AX_横断歩道
AX_機械式駐車場_昇降横行式	AX_機械式駐車場_単純昇降ピット式	AX_高木 1_2D	AX_高木 2_2D	AX_高木 3_2D
AX_皿型縁塊(U形)	AX_皿型縁塊用柵(U形)	AX_車椅子マーク	AX_受水槽_基礎	AX_集水柵化粧蓋

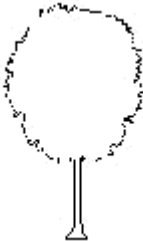
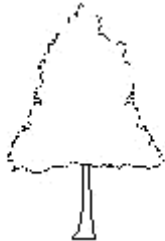





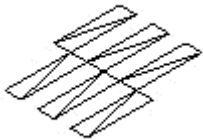
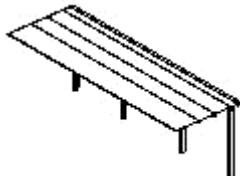

06 外構・点景>外構

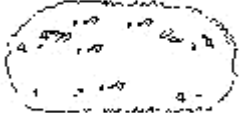
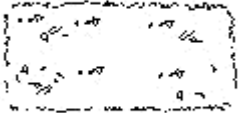
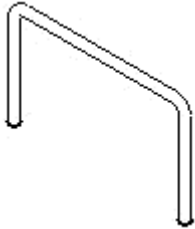
				
AX_乗用車マーク	AX_身障者駐車スペース	AX_側溝_L形(車乗り入れ部)H50	AX_側溝_L形(歩行者横断用タイプ1)H20	AX_側溝_L形
				
AX_側溝_L形外R	AX_側溝_L形A	AX_側溝_L形A外R1	AX_側溝_L形AE(車乗り入れ部)H50	AX_側溝_L形C
				
AX_側溝_L形用集水ます縁塊(歩行者横断用)H20	AX_側溝_L形用集水ます縁塊	AX_側溝_U形	AX_側溝_U形用ふた	AX_側溝_V形
				
AX_側溝_V形R	AX_側溝_グレーチング	AX_側溝_皿型(U形)	AX_側溝_皿型(一般)	AX_側溝_皿型コーナー(U形)





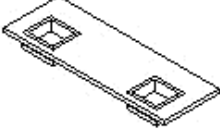



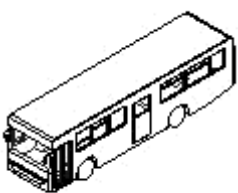

06 外構・点景＞外構

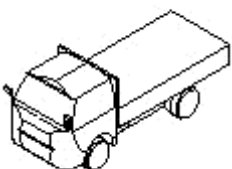
				
AX_側溝_皿型コーナ ー(一般)	AX_側溝_皿型集水(U 形)	AX_側溝_皿型集水端 部(U形)	AX_側溝_皿型端部(U 形)	AX_側溝_皿型端部 (一般)
				
AX_側溝_落ちふた式U 形	AX_側溝_落ちふた式U 形用ふた_1種	AX_側溝_落ちふた式 U形用ふた_3種	AX_側溝_落ちふた式U 形用ふた_グレーチング	AX_中木 1_2D
				
AX_中木 2_2D	AX_中木 3_2D	AX_駐車区画線_I	AX_駐車区画線_U	AX_駐車場
				
AX_駐車場_複数	AX_駐輪場 1	AX_駐輪場 2	AX_駐輪場 3	AX_駐輪場屋根

06 外構・点景＞外構

				
AX_低木 1_2D	AX_低木 2_2D	AX_転倒防止柵	AX_標識(一方通行)	AX_標識(止まれ)
				
AX_標識(駐車禁止)	AX_標識(独立型)	AX_標識(防火水槽)	AX_標識_基礎	AX_防火水槽_基礎
				
AX2_パーキングブロック_コンクリート				



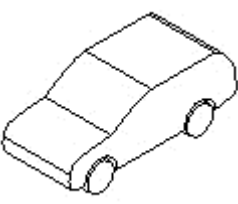
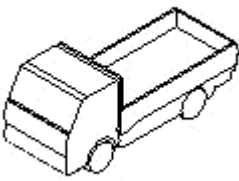
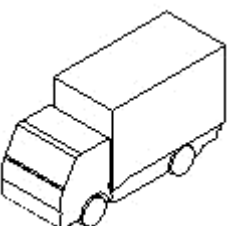
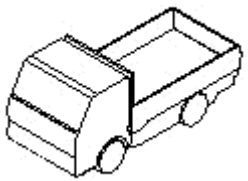
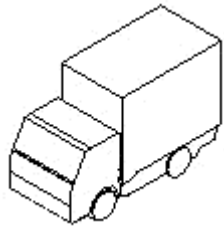
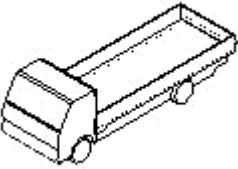
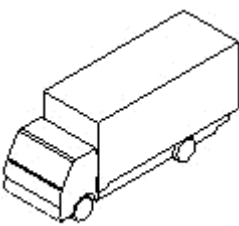
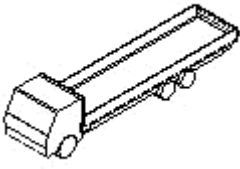
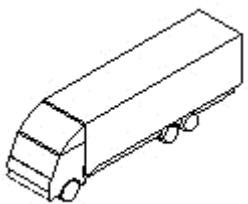







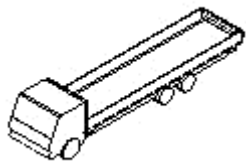
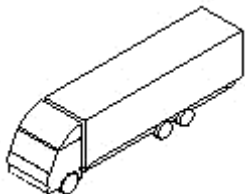
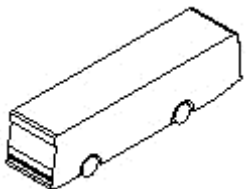
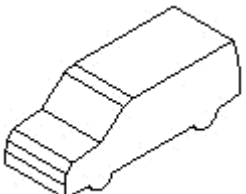
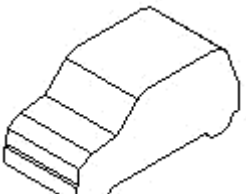
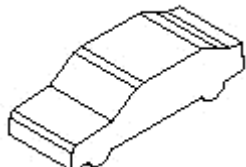



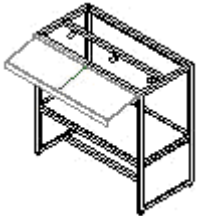
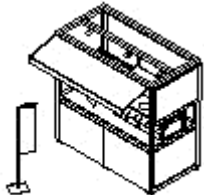

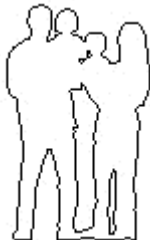

06 外構・点景 > 点景

				
AX_Bicycle	AX_Bus	AX_Car01	AX_Truck	AAX_キッチンカー_バ
				
AX_キッチンカー_軽自 動車	AX_のぼり旗	AX_家族 1	AX_子供 1	AX_子供 2
				
AX_子供 3	AX_車_SUV	AX_車_トラック 2t	AX_車_トラック 2t_箱 型	AX_車_トラック 4t
				
AX_車_トラック 4t_箱 型	AX_車_トラック 8t	AX_車_トラック 8t_箱 型	AX_車_トラック 12t	AX_車_トラック 12t_箱 型

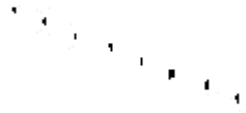
AReX-Style Family Library 2022/2024

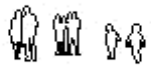
arex-style.com

06 外構・点景 > 点景

				
AX_車トラック 14t	AX_車トラック 14t 箱型	AX_車_バス	AX_車_ミニバン	AX_車_小型
				
AX_車_大型	AX_車_中型	AX_車いす	AX_車いす_面付き	AX_出店
				
AX_出店セット	AX_女性 1	AX_女性 2	AX_男性 1	AX_男性 2
				
AXt_家族 1	AXt_子供 1	AXt_子供 2	AXt_子供 3	AXt_歩道用歩行者
				
AXt_人物_オフィス出入口用	AXt_人物_マンション出入口用	AXt_女性 1	AXt_女性 2	AXt_男性 1

06 外構・点景 > 点景



AXt_男性 2

AReX-Style Family Library 2022/2024

arex-style.com

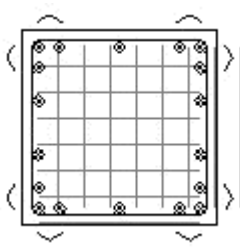
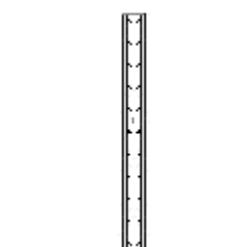
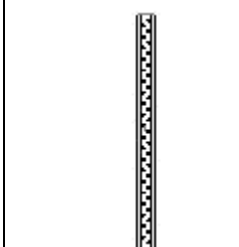
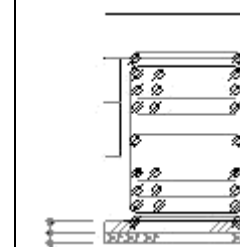
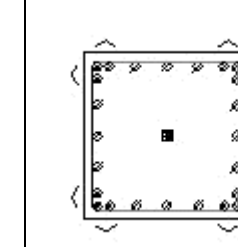
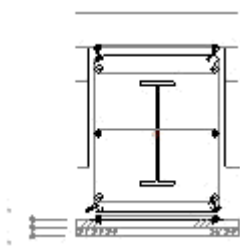
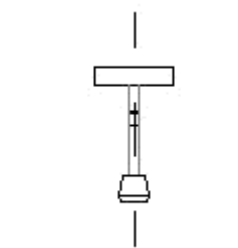
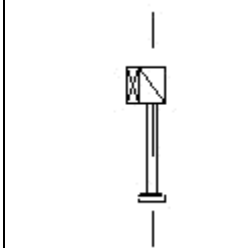
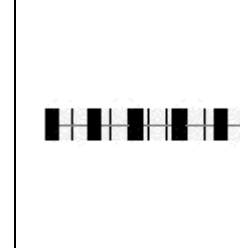
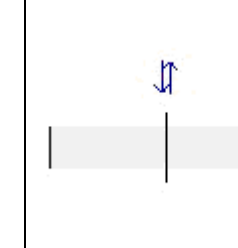
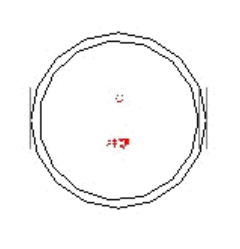
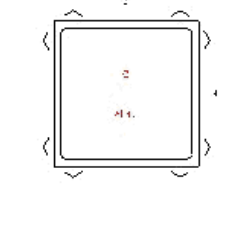
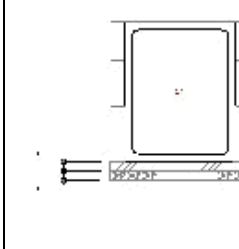
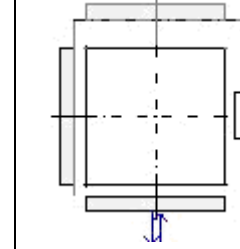
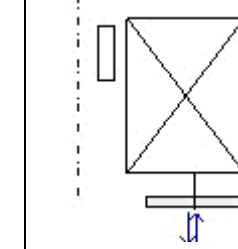
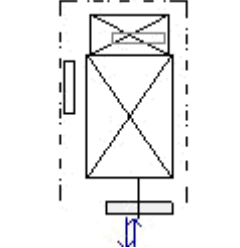
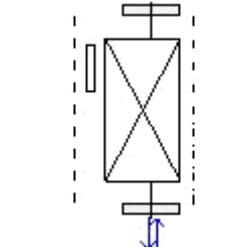
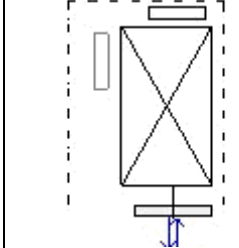
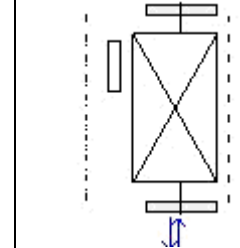
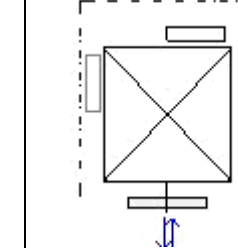

07 詳細・プロファイル > 詳細

				
AX_RC 柱断面リスト 用詳細	AX_RC 壁断面リスト 用詳細ダブル	AX_RC 壁断面リスト 用詳細チドリダブル	AX_RC 梁断面リスト 用詳細	AX_SRC 柱断面リスト 用詳細
				
AX_SRC 梁断面リスト 用詳細	AX2_乾式二重床_支持 脚	AX2_乾式二重床_支 持脚_際根太	AXi2_カーテンウォール	AXi2_開口
				
AXstb_RC 円形柱断 面リスト用詳細	AXstb_RC 矩形柱断 面リスト用詳細	AXstb_RC 梁断面リス ト用詳細	AXt2_EV_ダムウエー ター	AXt2_EV_荷物用
				
AXt2_EV_住宅用_片 引き戸	AXt2_EV_住宅用_片 引き戸_2 方向	AXt2_EV_乗用_片引 き戸	AXt2_EV_乗用_片引 き戸_2 方向	AXt2_EV_乗用_両引 き戸

07 詳細・プロファイル > 詳細

AXt2_EV_乗用_両引き戸_2方向	AXt2_EV_寝台用_片引き戸	AXt2_EV_寝台用_片引き戸_2方向	AXt2_EV_非常用_両引き戸	AXt2_FIX_窓
AXt2_シャッター	AXt2_引違い窓	AXt2_開口	AXt2_角柱	AXt2_自動ドア_片引き
AXt2_自動ドア_両分け	AXt2_住宅用 EV	AXt2_乗用 EV	AXt2_親子開き扉_フラッシュ	AXt2_片引き戸_フラッシュ
AXt2_片開き扉_フラッシュ	AXt2_両開き扉_フラッシュ			

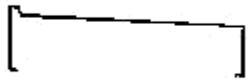
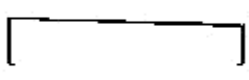
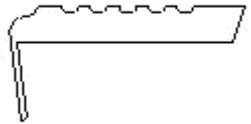
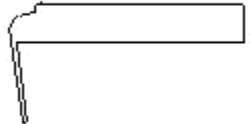
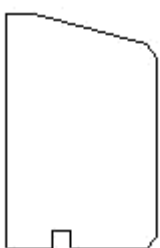
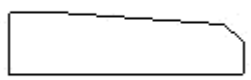
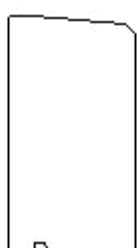
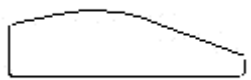
07 詳細・プロファイル > プロファイル

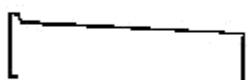
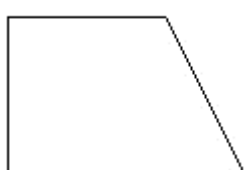
				
AX_(プ)アルミ笠木 1	AX_(プ)アルミ笠木 2	AX_(プ)ノンスリップ 1	AX_(プ)ノンスリップ 2	AX_(プ)パラペットアゴ
				
AX_(プ)パラペット上 部	AX_(プ)バルコニー立 上	AX_(プ)手摺笠木 1	AX_(プ)手摺笠木 2	AX_(プ)手摺笠木 3
				
AX_プロファイル_アル ミ笠木 W250	AX_プロファイル_水切	AXt2_乗用 EV	AXt2_親子開き扉_フ ラッシュ	AXt2_片引き戸_フラ ッシュ

AReX-Style Family Library 2022/2024

arex-style.com

08 タグ・記号・図面枠・タイトル > AXS

				
AXS_FAMILY_枠	AXS_FAMILY 外構	AXS_FAMILY 外部	AXS_FAMILY 躯体	AXS_FAMILY 建具
				
AXS_FAMILY 内部	AXS_FAMILY 部材	AXS_FAMILY 部材_枠	AXS_MAT_枠	AXS_MAT 外構
				
AXS_MAT 外部け	AXS_MAT 躯体	AXS_MAT 建具	AXS_MAT 内部	AXS_外部
				
AXS_外部_枠	AXS_建具	AXS_建具_枠	AXS_標準建具仕様	AXS_標準建具仕様_枠
				
AXS_標準仕上	AXS_標準仕上_枠	AXS_部屋	AXS_部屋_枠	AXSi_標準建具仕様

AReX-Style Family Library 2022/2024

arex-style.com

08 タグ・記号・図面枠・タイトル > AXS

AXS-T_MAT 内部	AXS-T_MAT 内部_枠			





08 タグ・記号・図面枠・タイトル > タグ

AX_A3 展開図用仕上表_実施-1	AX_A3_外部仕上表 A	AX_A3_建具表枠 A	AX_A3_仕上表 A	AX_A3_仕上表 B
AX_A3_仕上表 C	AX_CW タグ_実施-1	AX_エリアタグ_実施-1	AX_エリアタグ_住戸ユニット面積表示用	AX_エリアタグ_平詳用
AX_エリアタグ 1 L	AX_エリアタグ 1 M	AX_エリアタグ 1 S	AX_エリアタグ 2_ユニット名 L	AX_エリアタグ 2_ユニット名 M

AReX-Style Family Library 2022/2024

arex-style.com











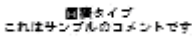



08 タグ・記号・図面枠・タイトル>タグ

<p>ROOMタイプ 表示面積 [表示面積]</p>	<p> m² [m²]</p>	<p>() m² [() m²]</p>		
AX_エリアタグ 2_ユニット名 S	AX_エリアタグ 3_求積表	AX_エリアタグ 3_減算_求積表	AX_エリアタグ 3_番号	AX_エリアタグ 4
	<p>ROOM (帖計算J)</p>	<p>名前 (帖計算J)</p>	<p>ROOM 150 [150]</p>	<p>ROOM 150 [150]</p>
AX_エリアタグ 4_求積表	AX_エリアタグ 5	AX_エリアタグ 5_J 表示	AX_エリアタグ 6_一般部 L	AX_エリアタグ 6_一般部 M
<p>ROOM 180 [180]</p>	<p>ユニットタイプ 表示面積 [表示面積]</p>	<p>ユニットタイプ 表示面積 [表示面積]</p>	<p>ユニットタイプ 表示面積 [表示面積]</p>	<p>名前 A 表示面積 [表示面積]</p>
AX_エリアタグ 6_一般部 S	AX_エリアタグ 6_一般部_ユニット名 L	AX_エリアタグ 6_一般部_ユニット名 M	AX_エリアタグ 6_一般部_ユニット名 S	AX_エリアタグ 6_一般部_名前+ユニット名 L
<p>名前 A 表示面積 [表示面積]</p>	<p>名前 A 表示面積 [表示面積]</p>	<p>ROOM 150.55 m² 99.99 m²</p>		<p>図面タイプ Aタイプ</p>
AX_エリアタグ 6_一般部_名前+ユニット名 M	AX_エリアタグ 6_一般部_名前+ユニット名 S	AX_エリアタグ 6_主要部	AX_ドアタグ_実施-1	AX_マスタグ 1

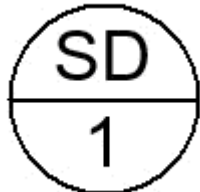
AReX-Style Family Library 2022/2024

arex-style.com











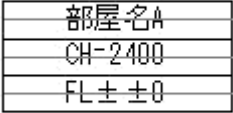
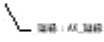
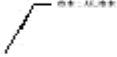
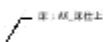



08 タグ・記号・図面枠・タイトル>タグ

 <p>図面タイプ これはサンプルのコメントです</p>	<p>住戸 A</p>	<p>面ROOM 表図面 [表図面枠]</p>		<p>床説明</p>																		
<p>AX_マスタグ 2</p>	<p>AX_マスタグ 3_名前 +ユニット名</p>	<p>AX_マス床タグ 1_S</p>	<p>AX_マス床タグ 2_ユニ ット名</p>	<p>AAX_マテリアルタグ_ 説明_L</p>																		
																						
<p>AX_マルチカテゴリタ グ_タイプマーク丸囲 み</p>	<p>AX_マルチカテゴリタ グ_説明_L</p>	<p>AX_マルチカテゴリタ グ_説明_LL</p>	<p>AX_マルチカテゴリタ グ_説明_M</p>	<p>AX_求積表タグ 1</p>																		
				<table border="1" data-bbox="1260 1243 1460 1310"> <tr> <td>F1</td> <td>-100(5050)</td> </tr> <tr> <td></td> <td>100+250+100</td> </tr> </table>	F1	-100(5050)		100+250+100														
F1	-100(5050)																					
	100+250+100																					
<p>AX_建具タグ_実施-1</p>	<p>AX_建具記号</p>	<p>AX_構造フレームタグ_軀 体図用</p>	<p>AX_構造基礎タグ_軀 体図用</p>	<p>AX_構造床タグ_軀 体 図用</p>																		
			<table border="1" data-bbox="957 1568 1197 1792"> <tr><td>層名</td><td>室名</td></tr> <tr><td>床</td><td>床仕上げ</td></tr> <tr><td>床下</td><td>床下地盤(1)・(2)・(3)</td></tr> <tr><td>壁</td><td>壁仕上げ</td></tr> <tr><td>天井</td><td>天井</td></tr> <tr><td>天井</td><td>天井仕上げ</td></tr> <tr><td>欄干</td><td>欄干</td></tr> </table>	層名	室名	床	床仕上げ	床下	床下地盤(1)・(2)・(3)	壁	壁仕上げ	天井	天井	天井	天井仕上げ	欄干	欄干	<table border="1" data-bbox="1308 1635 1412 1736"> <tr><td>部屋名A</td></tr> <tr><td>±0</td></tr> <tr><td>(-100)</td></tr> <tr><td>床仕上げ</td></tr> </table>	部屋名A	±0	(-100)	床仕上げ
層名	室名																					
床	床仕上げ																					
床下	床下地盤(1)・(2)・(3)																					
壁	壁仕上げ																					
天井	天井																					
天井	天井仕上げ																					
欄干	欄干																					
部屋名A																						
±0																						
(-100)																						
床仕上げ																						
<p>AX_構造柱タグ_軀 体 図用</p>	<p>AX_構造壁タグ_軀 体 図用</p>	<p>AX_窓タグ_実施-1</p>	<p>AX_展開図用仕上表</p>	<p>AX_部屋タグ_実施-1</p>																		

AReX-Style Family Library 2022/2024

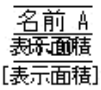
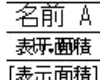
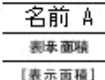
arex-style.com







08 タグ・記号・図面枠・タイトル>タグ

				
<p>AX_部屋タグ_実施-2</p>	<p>AX_部屋タグ_展開図 廻縁</p>	<p>AX_部屋タグ_展開図 巾木</p>	<p>AX_部屋タグ_展開図 床仕上</p>	<p>AX_部屋タグ_展開図 天井仕上 L</p>
				
<p>AX_部屋タグ_展開図 壁仕上</p>	<p>AX_部屋タグ_平詳用</p>	<p>AX_部屋タグ 1 L</p>	<p>AX_部屋タグ 1 M</p>	<p>AX_部屋タグ 1 S</p>
				
<p>AX_部屋タグ 2_ユニット名 L</p>	<p>AX_部屋タグ 2_ユニット名 M</p>	<p>AX_部屋タグ 2_ユニット名 S</p>	<p>AX_部屋タグ 6_一般部</p>	<p>AX_部屋タグ 6_一般部_名前+ユニット名 L</p>
				
<p>AX_部屋タグ 6_一般部_名前+ユニット名 M</p>	<p>AX_部屋タグ 6_一般部_名前+ユニット名 S</p>	<p>AX_部屋タグ 6_主要部</p>	<p>AXi_A3_建具表 A</p>	<p>AXi_A3_建具表 B</p>

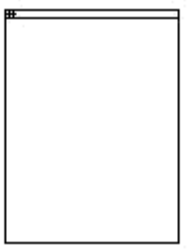
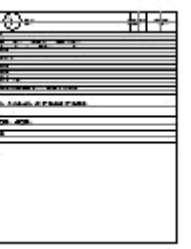
AReX-Style Family Library 2022/2024

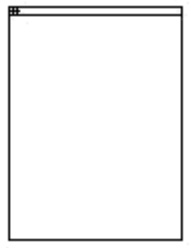
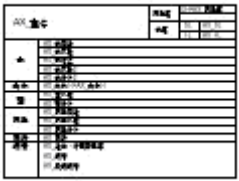
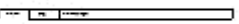
arex-style.com

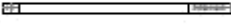
08 タグ・記号・図面枠・タイトル>タグ

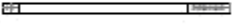
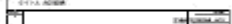
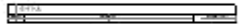
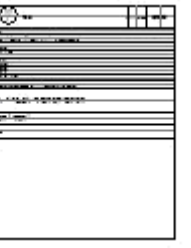
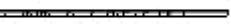
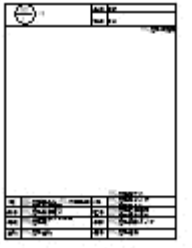
				
AXi_A3_建具表 C	AXi_A3_建具別紙 B	AXt_A3_建具表 A	AXt_A3_建具表 B	AXt_A3_建具表 C
				
AXt_A3_建具別紙 B	AX_A1 展開図用仕上表_実施-1	AX_A1_外部仕上表 A	AX_A1_建具表枠 A	AX_A1_仕上表 A
				
AX_A1_仕上表 B	AX_A1_仕上表 C	AX_求積表タグ 2_小計	AX_求積表タグ 2_小計桁処理	AX_求積表タグ 3_合計
				
AX_求積表タグ 3_合計桁処理	AX_求積表枠 1	AXi_A1_建具表 A	AXi_A1_建具表 B	AXi_A1_建具表 C

08 タグ・記号・図面枠・タイトル>タグ

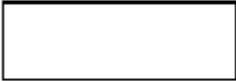
				
AXi_A1_建具別紙 B	AXt_A1_建具表 A	AXt_A1_建具表 B	AXt_A1_建具表 C	AXt_A1_建具表 C
				
AXt_A1_建具別紙 B				











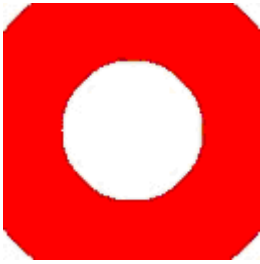
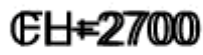
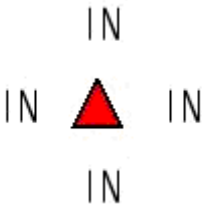
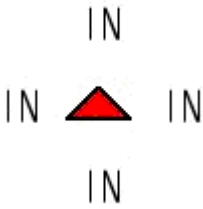
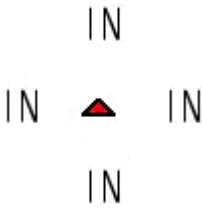
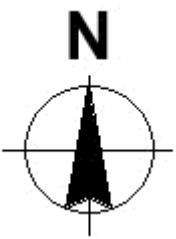
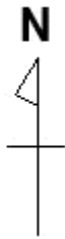
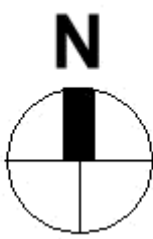

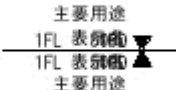

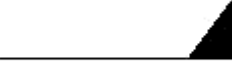

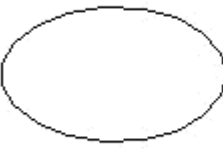
08 タグ・記号・図面枠・タイトル>ビュータイトル

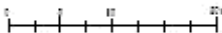
	<u>A 1F エントランス</u>			
AX_ビュータイトル_囲み	AX_ビュータイトル_展開図用			

AReX-Style Family Library 2022/2024

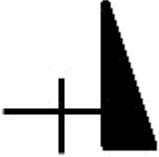
arex-style.com

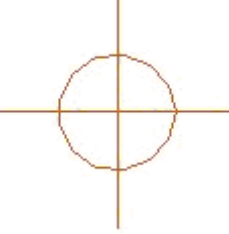
08 タグ・記号・図面枠・タイトル＞記号

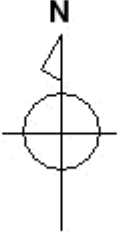
				
AX_CK_壁の分割	AX_2D 段差記号	AX_Arrow_WL	AX_Arrow_WM	AX_Arrow_WS
				
AX_Orientation_A	AX_Orientation_B	AX_Orientation_C	AX_PS 記号	AX_レベル記号
				
AX_記号_円 2 重	AX_A1_仕上表 C	AX_記号_矢印	AX_指定点高さ_矩形	AX_指定点高さ_楕円
				
AX_縮尺 1	AX_縮尺 2	AX_縮尺 3	AX_水勾配矢印_表記 上	AX_水勾配矢印_表記 上下
				
AX_断面図記号	AX_通芯記号	AX_敷地基準点	AX_敷地境界点	AX_方位 1







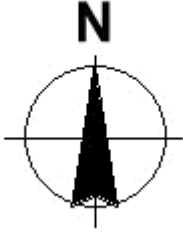
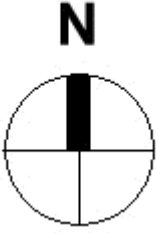





AReX-Style Family Library 2022/2024

arex-style.com

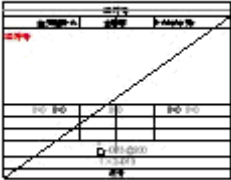
08 タグ・記号・図面枠・タイトル＞記号

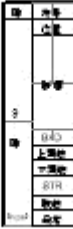
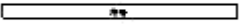
				
AX_方位 2	AX_方位 3			



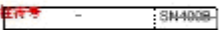







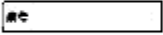

08 タグ・記号・図面枠・タイトル＞構造

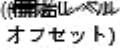
				
AX_RC 柱_断面表タグ 1	AX_RC 柱_断面表枠	AX_RC 柱_断面表枠 _1	AX_RC 柱_断面表枠_ 符号	AX_RC 壁_断面表タグ 1
				
AX_RC 壁_断面表枠 _1	AX_RC 梁_断面表タグ	AX_RC 梁_断面表枠	AX_RC 梁_断面表枠 _1	AX_RC 梁_断面表枠_ 符号
				
AX_SRC 柱_断面表タグ	AX_SRC 柱_断面表枠	AX_SRC 梁_断面表タグ	AX_SRC 梁_断面表枠	AX_S 柱_断面表タグ

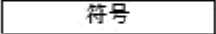
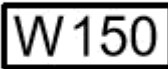
AReX-Style Family Library 2022/2024

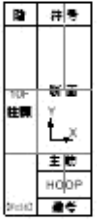
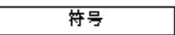
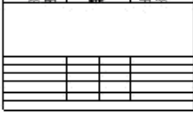
arex-style.com















08 タグ・記号・図面枠・タイトル＞構造

				
AX_S 柱_断面表枠	AX_S 部材_断面表枠 _備考	AX_S 梁_断面表タグ	AX_S 梁_断面表枠	AX_構造_断面表枠_符号
		P1 P1	S1	C1 C1 C1
AX_構造フレームタグ_天端レベル	AX_構造フレームタグ_符号	AX_構造基礎タグ_符号	AX_構造床タグ_符号	AX_構造柱タグ_符号
W1				
AX_構造壁タグ_符号	AX_柱_断面表枠_符号	AX_壁タグ_符号	AXstb_RC 柱_断面表タグ	AXstb_RC 柱_断面表枠
				
AXstb_RC 柱_断面表枠_符号	AXstb_RC 梁_断面表タグ	AXstb_RC 梁_断面表枠	AXstb_S 柱_断面表タグ	AXstb_S 部材_断面表枠

08 タグ・記号・図面枠・タイトル＞構造

				
AXstb_S 部材_断面表 枠_備考	AXstb_構造_断面表 枠_符号			











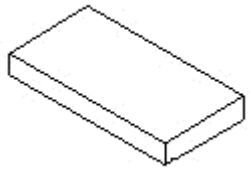
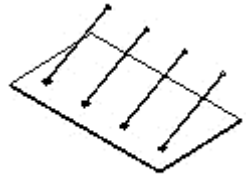
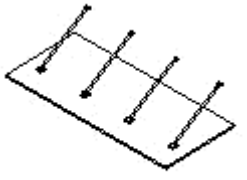

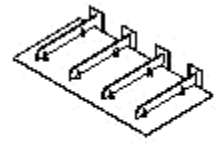

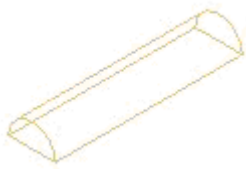

08 タグ・記号・図面枠・タイトル＞図面枠

				
AX_A3_図面枠 1	AX_A3_図面枠_外部 仕上表 A	AX_A3_図面枠_概要 書_1	AX_A3_図面枠_建具 表 A	AX_A3_図面枠_建具 表 B
				
AX_A3_図面枠_仕上 表 A	AX_A3_図面枠_仕上 表 B	AX_A3_図面枠_仕上 表 C	AX_A1_図面枠	AX_A1_図面枠_外部 仕上表 A
				
AX_A1_図面枠_建具 表 A	AX_A1_図面枠_建具 表 B	AX_A1_図面枠_仕上 表 A	AX_A1_図面枠_仕上 表 B	AX_A1_図面枠_仕上 表 C

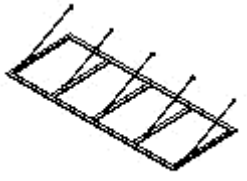
AReX-Style Family Library 2022/2024

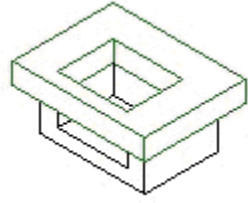
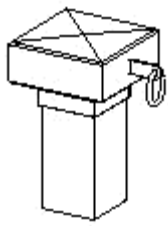
arex-style.com

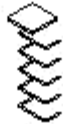
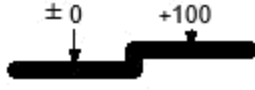









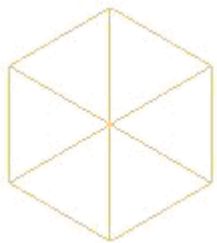

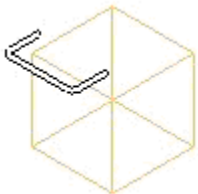
09 その他

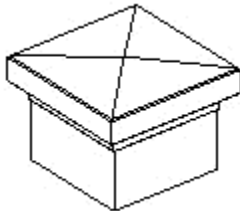
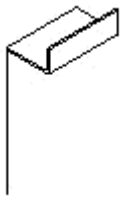
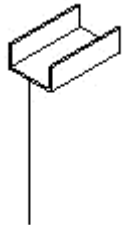
				
AX_RC 小庇	AX_アルミパネル庇 1	AX_アルミパネル庇 2	AX_アルミ小庇	AX_ガラス庇
				
AX_スリーブ	AX_スリーブ_半割	AX_タラップ	AX_ドレンレール	AX_パーゴラ
				
AX_ブラインドBOX	AX_ポイド_水切	AX_ポリカーボネート庇	AX_マンホール_タラップ付	AX_釜場
				
AX_丸環用基礎_防水押え金物付	AX_金物_コーナーガード	AX_床下点検口_タラップ付	AX_床段差	AX_人通口_円形

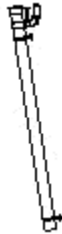
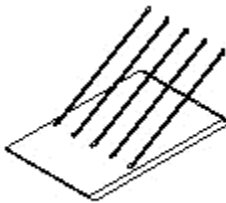
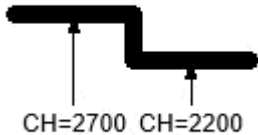
AReX-Style Family Library 2022/2024

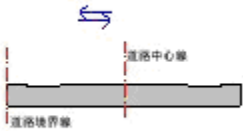
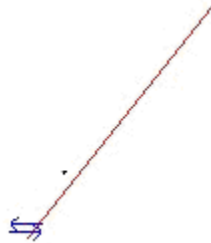
arex-style.com

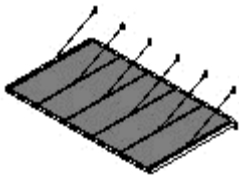
09 その他

				
AX_人通口_矩形	AX_人通口手掛付_円形	AX_人通口手掛付_矩形	AX_折板吊り庇	AX_設備アンテナ基礎_防水押え金物付
				
AX_耐火被覆 L型	AX_耐火被覆 コの字	AX_竖樋	AX_竖樋_傾斜	AX_鉄骨現わし大庇
				
AX_天井段差	AX_天井点検口	AX_道路	AX_道路斜線	AX_敷地境界線
				
AX_北側斜線	AX_落下防止庇	AX_隣地斜線		

AReX-Style Family Library 2022/2024

arex-style.com







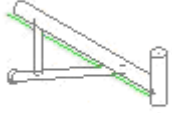
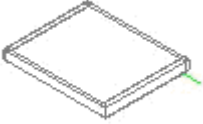

10 施工>足場

				
AX_クサビ式足場 A _アサガオ_1 スパン用	AX_クサビ式足場 A _アサガオ_コーナー用	AX_クサビ式足場 A _アサガオ _複数スパン用	AX_クサビ式足場 A _アンダーベース	AX_クサビ式足場 A _ジャッキベース
				
AX_クサビ式足場 A _セーフウィンドウ	AX_クサビ式足場 A _セーフウィンドウ複数 スパン用	AX_クサビ式足場 A _セーフクライマー	AX_クサビ式足場 A _セット	AX_クサビ式足場 A _タラップガード
				
AX_クサビ式足場 A _トラス 36	AX_クサビ式足場 A _トラス 54	AX_クサビ式足場 A _トラスセット	AX_クサビ式足場 A _ブラケット	AX_クサビ式足場 A _プレス
				
AX_クサビ式足場 A _階段	AX_クサビ式足場 A _階段手すり	AX_クサビ式足場 A _階段扉	AX_クサビ式足場 A _基礎セット	AX_クサビ式足場 A _支柱

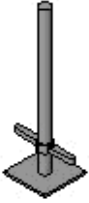
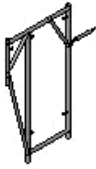
AReX-Style Family Library 2022/2024

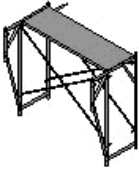
arex-style.com

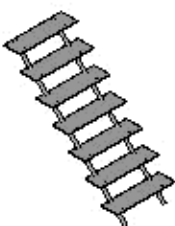
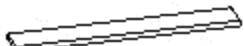
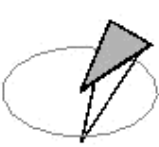
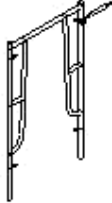
10 施工>足場

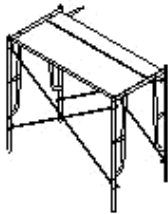
				
AX_クサビ式足場 A _手すり	AX_クサビ式足場 A _張出ブラケット	AX_クサビ式足場 A _踏板	AX_クサビ式足場 A _敷板	AX_ジャッキベース
				
AX_ブラケット枠 900 _たて枠のみ	AX_ブラケット枠 900 _片たて枠	AX_ブラケット枠 900 _両たて枠	AX_ブラケット枠 1200_たて枠のみ	AX_ブラケット枠 1200_片たて枠
				
AX_ブラケット枠 1200_両たて枠	AX_メッシュシート	AX_筋違い	AX_足場_階段	AX_足場板
				
AX_朝顔_コーナー部	AX_朝顔_直線部	AX_鳥居型枠 900 _たて枠のみ	AX_鳥居型枠 900 _片たて枠	AX_鳥居型枠 900 _両たて枠



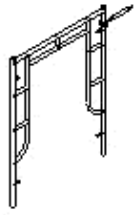
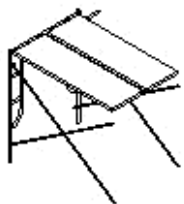
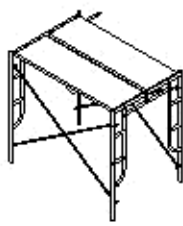
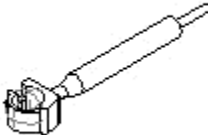
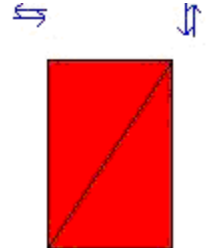







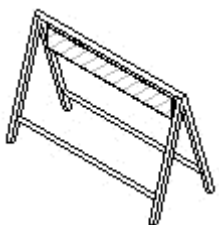
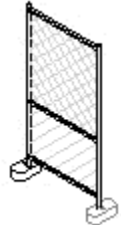
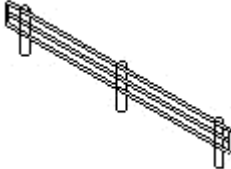
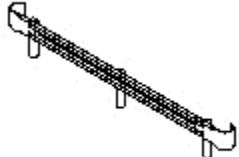

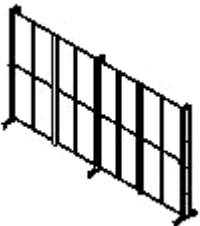

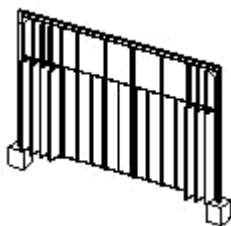
10 施工＞足場

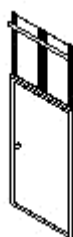
				
AX_鳥居型枠 1200 _たて枠のみ	AX_鳥居型枠 1200 _片たて枠	AX_鳥居型枠 1200 _両たて枠	AX_壁つなぎ	AXi_2D 足場

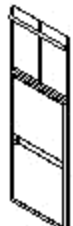

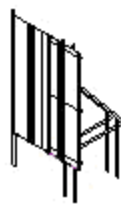

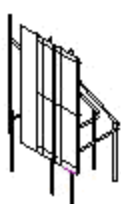
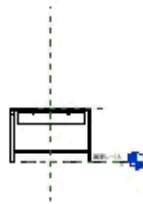
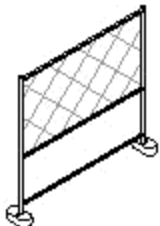

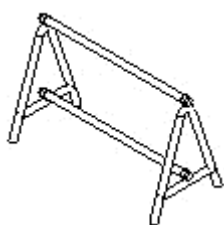
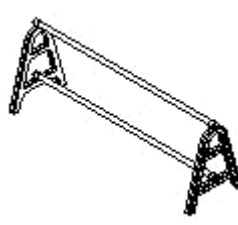
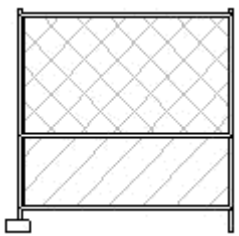
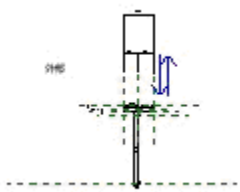

AReX-Style Family Library 2022/2024

arex-style.com



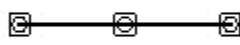
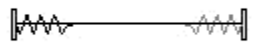

10 施工＞仮囲い

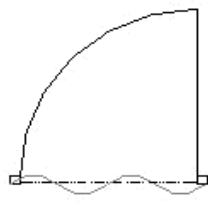
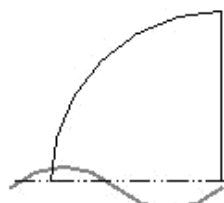
				
AX_A 型バリケード	AX_B 型バリケード	AX_ガードパイプ	AX_ガードレール	AX_カラーコーン H700
				
AX_キャスターゲート _片_H2100	AX_キャスターゲート _両_H2100	AX_パネルゲート	AX_仮囲い_コーナー フラットパネル	AX_仮囲いガルバリウ ム板_ドア W950
				
AX_仮囲いガルバリウ ム板_ドア_パネル付	AX_仮囲いフラットパネ ル_ドア W900	AX_仮囲い万能板	AX_仮囲い万能板 _ガルバリウム板	AX_仮囲い万能板 _ドア W900
				
AX_仮囲い万能板 _ドア_パネル付	AX_仮囲い万能板 _フラットパネル	AX_手すり子 _A 型バリケード	AX_手すり子 _B 型バリケード	AX_手すり子 _カラーコーン

10 施工＞仮囲い

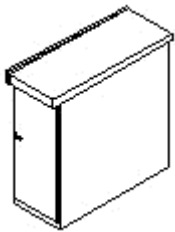
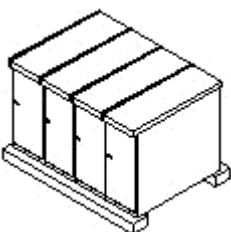
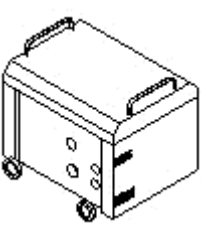
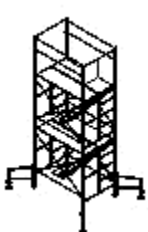
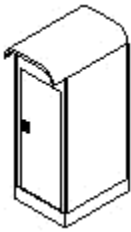
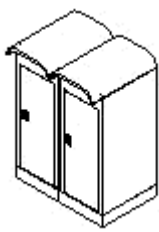
				
AX_単管バリケード	AX_単管バリケード樹脂	CW_B型バリケード	CW_仮囲いガルバリウム鋼板	CW_仮囲いフラットパネル
				
CW_仮囲いフラットパネルドア W900	AX2_ガードパイプ	AX2_ガードレール	AX2_カラーコーン H700	AX2_キャスターゲート片 H2100
				
AX2_キャスターゲート両 H2100	AX2_パネルゲート	AX2_仮囲い万能板	AX2_仮囲い万能板ドア W900	AX2_仮囲い万能板ドアパネル付

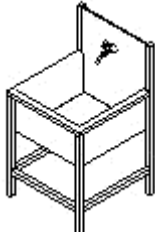

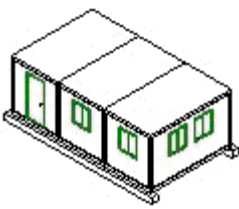
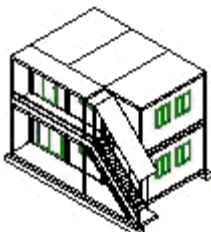
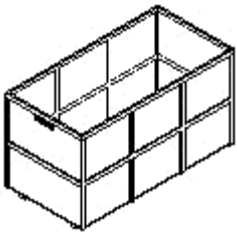
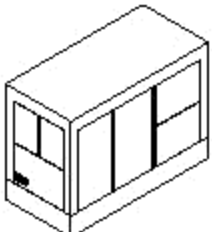









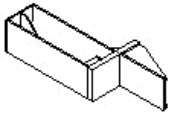

10 施工＞仮設

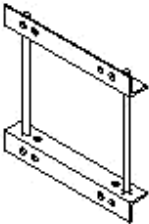
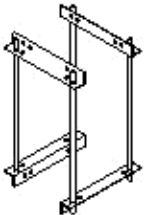
				
AX_キュービクル	AX_キュービクルセット	AX_ハイウォッシャー	AX_ローリングタワー	AX_仮設トイレ
				
AX_仮設トイレ_複数	AX_仮設敷鉄板	AX_仮設流し台	AX_可搬式作業台	AX_脚立
				
AX_現場事務所	AX_現場事務所 2F	AX_産廃置場	AX_発電機	

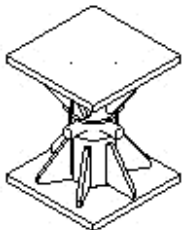
AReX-Style Family Library 2022/2024

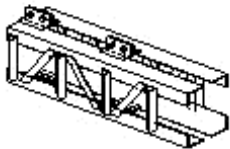
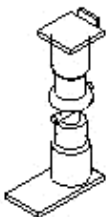
arex-style.com

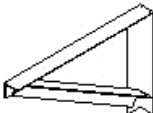
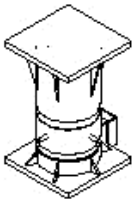
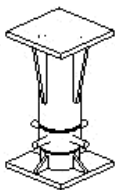

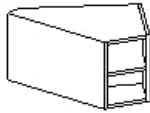







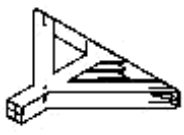
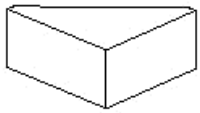



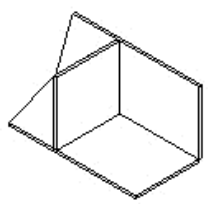
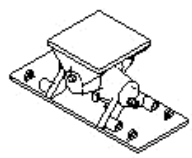

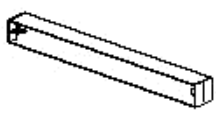
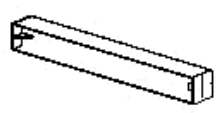
10 施工>山留め部材

				
AX_H形鋼_広幅系	AX_H形鋼_細幅系	AX_H形鋼_中幅系	AX_PS 取付金物	AX_U形鋼矢板 _W400
				
AX_U形鋼矢板 _W500	AX_U形鋼矢板 _W600	AX_アングルピース _セット	AX_アングルピース _ダブルセット	AX_カバープレート
				
AX_キリンジャッキ	AX_コーナー鋼矢板 _W400	AX_ジャッキカバー	AX_スチフナージャッキ	AX_ハット形鋼矢板 _W900用
				
AX_ブラケット	AX_プレロードジャッキ (土圧計付)	AX_プレロードジャッキ	AX_横矢板	AX_火打ち受ピース

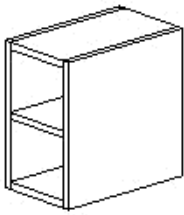
AReX-Style Family Library 2022/2024

arex-style.com



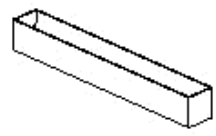

10 施工>山留め部材

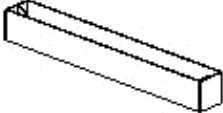
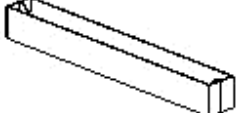
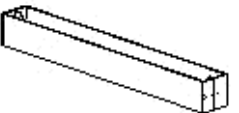
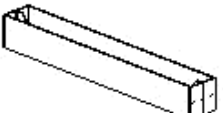
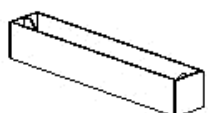
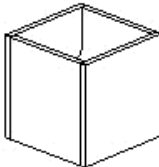
				
AX_火打ブリック	AX_隅部ピース	AX_軽量鋼矢板 _W250	AX_軽量鋼矢板 _W333	AX_溝形鋼
				
AX_自在火打受ピース	AX_斜梁受けピース	AX_切梁_200用 _L1000-L7000	AX_切梁_250用 _L1000-L7000	AX_切梁_300用 _L1000-L7000
				
AX_切梁_350用 _L1000-L7000	AX_切梁_400用 _L1000-L7000	AX_切梁_500用 _L1000-L7000	AX_切梁_補助ピース	AX_直ボルト
				
AX_直線形鋼矢板 _400-500用	AX_等辺山形鋼	AX_不等辺山形鋼	AX_敷鉄板	AX_腹起_200用 _L1000-L7000



10 施工>山留め部材

				
AX_腹起_250用 _L1000-L7000	AX_腹起_300用 _L1000-L7000	AX_腹起_350用 _L1000-L7000	AX_腹起_400用 _L1000-L7000	AX_腹起_500用 _L1000-L7000
				
AX_腹起_補助ピース				

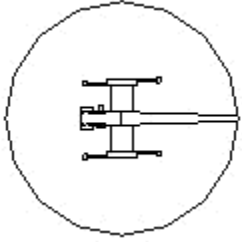
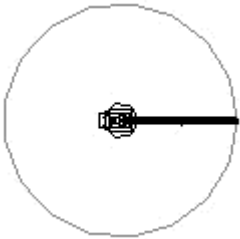
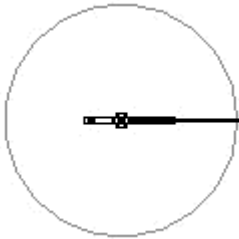
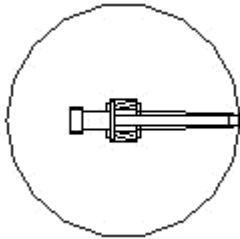





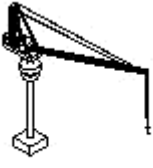
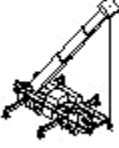
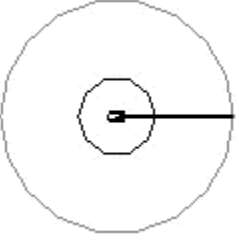
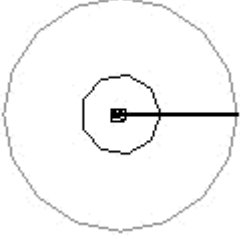
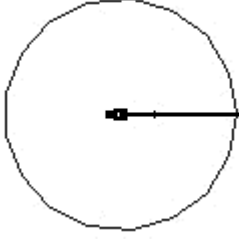
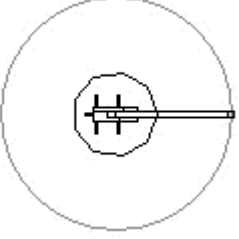

10 施工＞荷揚げ機械

				
AX_ジブクレーン	AX_タートクレーン	AX_トンボクレーン	AX_軽便ジブクレーン	AX2_ジブクレーン
				
AX2_タートクレーン	AX2_トンボクレーン	AX2_軽便 ジブクレーン		

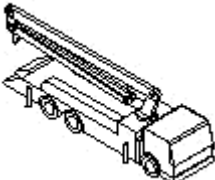
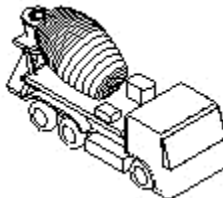
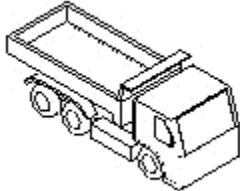
10 施工＞鉄骨建方機械

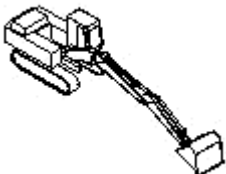
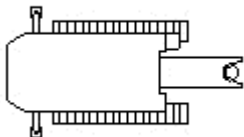
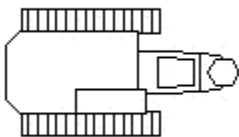
				
AX_クローラクレーン	AX_タワークレーン _120t	AX_タワークレーン _400t	AX_油圧クレーン	AX2_クローラクレーン
				
AX2_タワークレーン _120t	AX2_タワークレーン _400t	AX2_油圧クレーン		



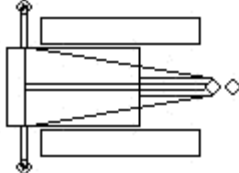
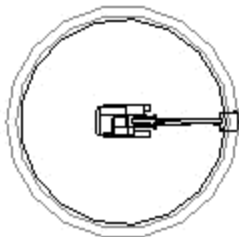





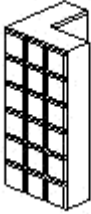
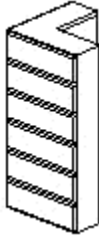

10 施工＞その他機械

				
AX_アースオーガー	AX_アースドリル	AX_コンクリートポンプ車	AX_コンクリートミキサー車	AX_ダンプトラック
				
AX_パイルドライバー	AX_バックホウ	AX2_アースオーガー	AX2_アースドリル	AX2_コンクリートポンプ車
				
AX2_コンクリートミキサー車	AX2_ダンプトラック	AX2_パイルドライバー	AX2_バックホウ	

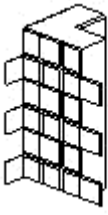
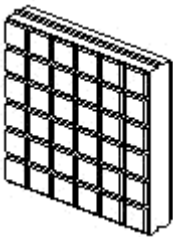
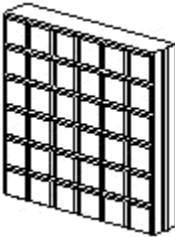
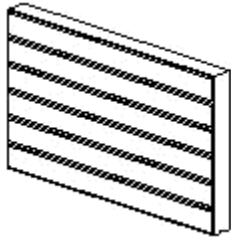
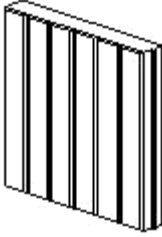
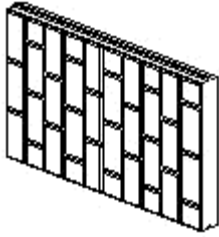
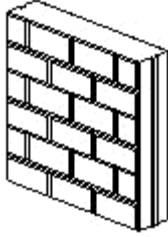
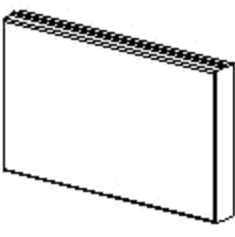
AReX-Style Family Library 2022/2024

arex-style.com

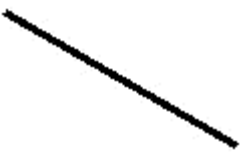













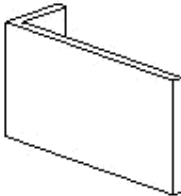
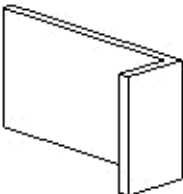
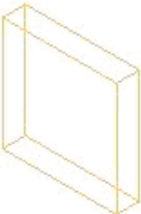

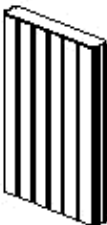
10 施工＞下地割付

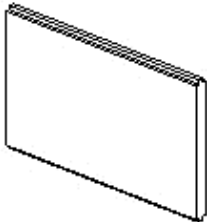
				
AX_ALC コーナーパネル	AX_ALC コーナーパネル_クロスデザイン_横張用	AX_ALC コーナーパネル_クロスデザイン_縦張用	AX_ALC コーナーパネル_ストライプデザイン_横張用	AX_ALC コーナーパネル_ストライプデザイン_縦張用
				
AX_ALC コーナーパネル_レンガ調デザイン_横張用	AX_ALC コーナーパネル_レンガ調デザイン_縦張用	AX_ALC パネル_クロスデザイン_横張用	AX_ALC パネル_クロスデザイン_縦張用	AX_ALC パネル_ストライプデザイン_横張用
				
AX_ALC パネル_ストライプデザイン_縦張用	AX_ALC パネル_レンガ調デザイン_横張用	AX_ALC パネル_レンガ調デザイン_縦張用	AX_ALC パネル_横張用	AX_ALC パネル_縦張用
				
AX_ALC 補強材_山型鋼_垂直	AX_ALC 補強材_山型鋼_水平	AX_LGS_WB	AX_LGS_WR	AX_LGS_WS

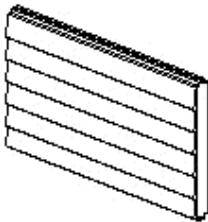
AReX-Style Family Library 2022/2024

arex-style.com

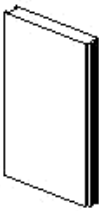









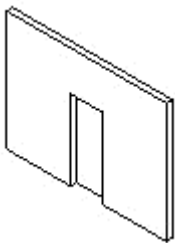
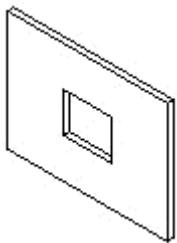
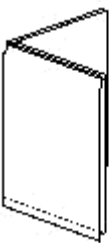

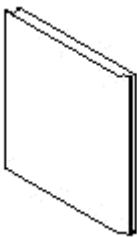

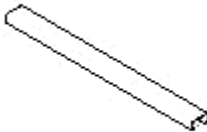
10 施工＞下地割付

				
AX_LGS 補強材_C型 鋼_垂直	AX_LGS 補強材_C型 鋼_水平	AX_LGS 補強材_角パイプ_垂直	AX_LGS 補強材_角パイプ_水平	AX_タイル_出隅材
				
AX_タイル_入隅材	AX_ボイド	AX_押出成形セメント板_ストライプデザイン_横張用	AX_押出成形セメント板_ストライプデザイン_横張用コーナー	AX_押出成形セメント板_ストライプデザイン_縦張用
				
AX_押出成形セメント板_スプライトデザイン_縦張用コーナー	AX_押出成形セメント板_横張用	AX_押出成形セメント板_横張用コーナー	AX_押出成形セメント板_三角デザイン_横張用	AX_押出成形セメント板_三角デザイン_横張用コーナー
				
AX_押出成形セメント板_三角デザイン_縦張用	AX_押出成形セメント板_三角デザイン_縦張用コーナー	AX_押出成形セメント板_縦張用	AX_押出成形セメント板_縦張用 R コーナー	AX_押出成形セメント板_縦張用コーナー

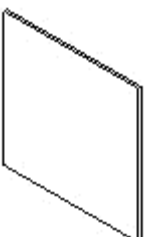
AReX-Style Family Library 2022/2024

arex-style.com



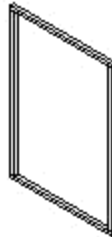













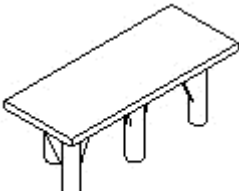

10 施工＞下地割付

				
AX_開口部_ドア	AX_開口部_窓	AX_金属サンドイッチ パネル_コーナー	AX_金属サンドイッチ パネル_横張用	AX_金属サンドイッチ パネル_横張用 _コーナー
				
AX_金属サンドイッチ パネル_縦張用	AX_胴縁_C型鋼 _垂直	AX_胴縁_C型鋼 _垂直_W	AX_胴縁_C型鋼 _水平	AX_胴縁_C型鋼 _水平_W
				
AX_胴縁_角パイプ _垂直	AX_胴縁_角パイプ _水平	AX_壁パネル	AX_壁用木下地_間柱	AX_壁用木下地 _脚固め
				
AX_壁用木下地 _端部間柱	AX_壁用木下地 _頭つなぎ	AX_壁用木下地_胴縁	AX_壁用木下地 _片引戸わく廻り	AX_壁用木下地 _片開き戸わく廻り

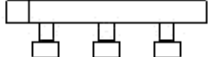









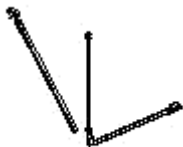

AReX-Style Family Library 2022/2024

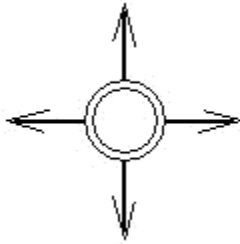
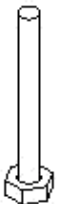
arex-style.com

10 施工>下地割付

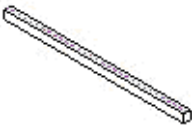
				
AX_OA フロア_アルミ見切	AX_OA フロア_パネル	AX_OA フロア_ベース_H50	AX_OA フロア_ベース_H75	AX_OA フロア_ベース_H100
				
AX_OA フロア_ベース_スロープ	AX_OA フロア_交点支柱	AX_OA フロア_切断加工ベース_H100	AX_OA フロア_補助支柱	AX_乾式二重床_PB
				
AX_根太	AX_際根太	AX_大引	AX_置き束_システム根太	AX_置き束_支持脚
				
AX_LGS_CC	AX_LGS_CS	AX_LGS_CW	AX_吊りボルト	AX_吊りボルト_2方向_ブレース付_野縁受方向

10 施工＞下地割付

				
AX_吊りボルト_2方向 ブレース付_野縁方向	AX_吊りボルト_4方向 ブレース付	AX_吊りボルト_ブレース付_野縁受方向	AX_吊りボルト_ブレース付_野縁方向	AX_天井割付基点
				
AX_天井用木下地 _インサートボルト 9φ	AX_天井用木下地 _一般階野縁受金物	AX_天井用木下地 _最上階野縁受金物	AX_天井用木下地 _補強野縁	AX_天井用木下地 _野縁
				
AX_目地	AX_目地_垂直	AX_目地_水平		