

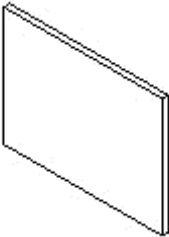

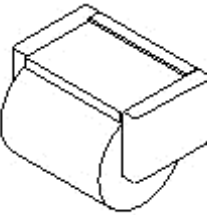

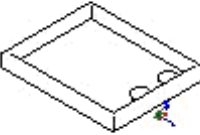

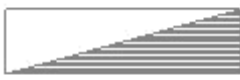
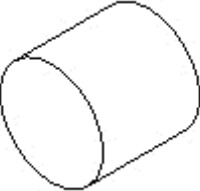

22 住宅設備＞室内

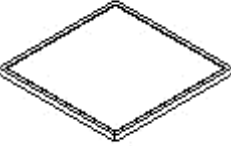
				
AX_タオルリング	AX_タオル掛け	AX_ペーパーホルダー	AX_洗濯機パン	AX_分電盤 01
				
AX_設備スリーブ				

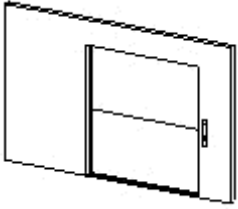
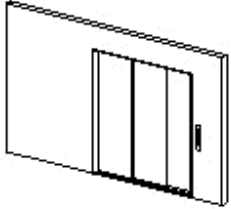

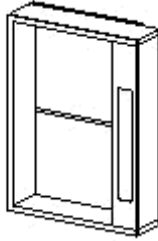

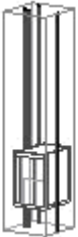
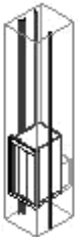
22 住宅設備＞室外

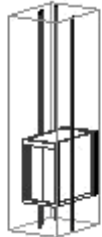
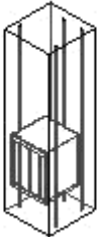
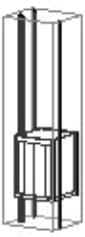
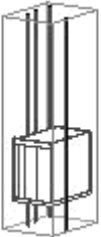
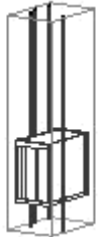
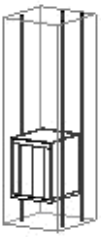
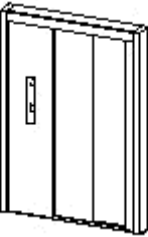
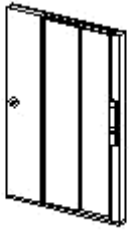
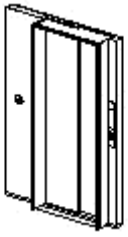
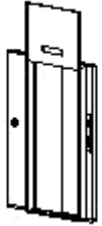
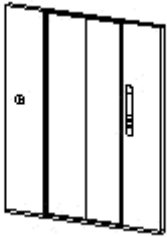
				
AX_バルコニー隔板	AX_手摺付き物干し	AX_避難ハッチ		

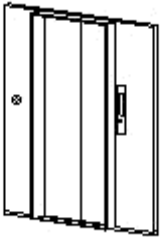
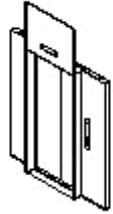
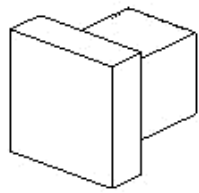
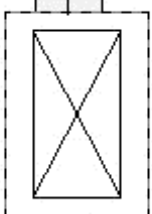

23 昇降機設備 > エレベータ(1)

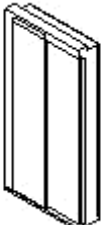
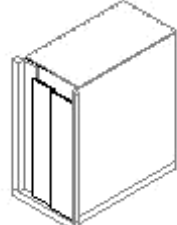
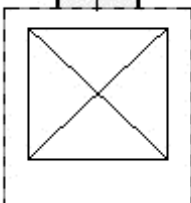
				
AX_EV_2枚上引き戸_小枠	AX_EV_3枚片引き戸_大枠	AX_EV_ダムウェーター	AX_EV_ダムウェーター扉_テーブルタイプ	AX_EV_ダムウェーター扉_フロアタイプ
				
AX_EV_荷物用	AX_EV_住宅用片引き戸	AX_EV_住宅用片引き戸_2方向	AX_EV_乗用片引き戸	AX_EV_乗用片引き戸_2方向
				
AX_EV_乗用両引き戸	AX_EV_乗用両引き戸_2方向	AX_EV_寝台用片引き戸	AX_EV_寝台用片引き戸_2方向	AX_EV_非常用両引き戸
				
AX_EV_片引き戸_パネル付	AX_EV_片引き戸_小枠	AX_EV_片引き戸_大枠	AX_EV_片引き戸_幕板付	AX_EV_両引き戸_小枠

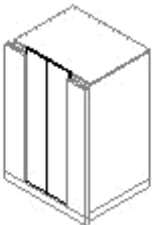
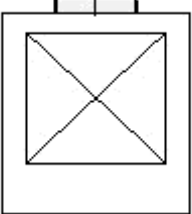

23 昇降機設備＞エレベータ(2)

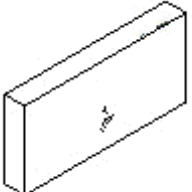
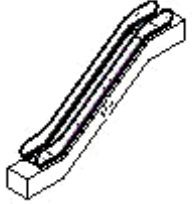
				
AX_EV_両引き戸_大 枠	AX_EV_両引き戸_幕 板付	AX_自火報用点検口	AX_住宅用 EV_2D	AX_住宅用 EV2D_小 枠
				
AX_住宅用 EV2D_大 枠	AX_住宅用 EV3D	AX_乗用 EV_2D	AX_乗用 EV2D_小枠	AX_乗用 EV2D_大枠
				
AX_乗用 EV3D	AXt_乗用 EV			

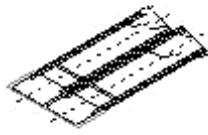
23 昇降機設備＞エスカレータ

				
AX_エスカレーター_2D	AX_エスカレーター_3D	AX_エスカレーター_1 台_2D	AX_エスカレーター_2 台_2D	



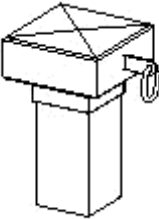
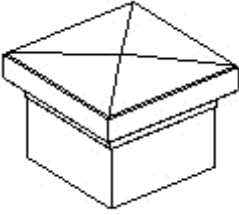



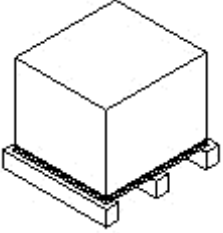
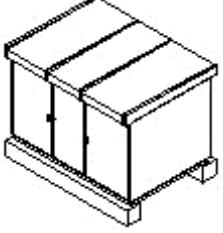
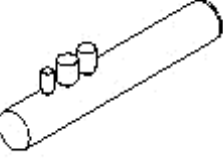
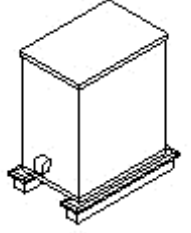



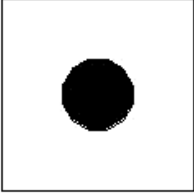

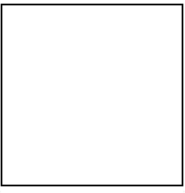
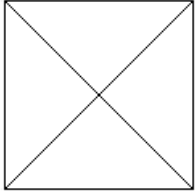

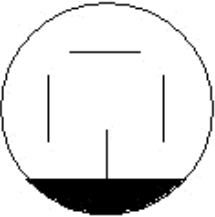

24 屋上設備

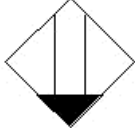
				
AX_タラップ	AX_ドレンレール	AX_丸環用基礎_防水 押え金物付	AX_設備アンテナ基礎 _防水押え金物付	



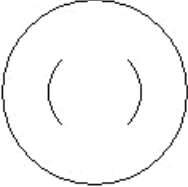
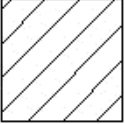



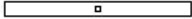

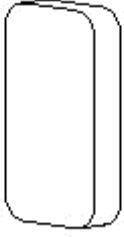

25 特殊設備

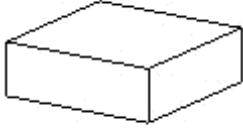
				
AX_受水槽	AX_連結送水管ブー スターポンプ	AX_オイルタンク	AX_燃料タンク	

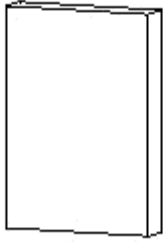
26 設備 > 2D

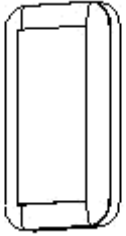
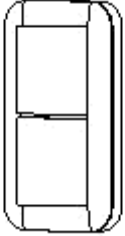
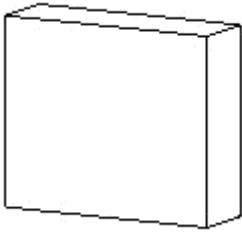
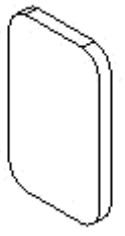
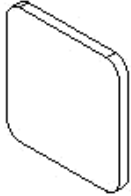
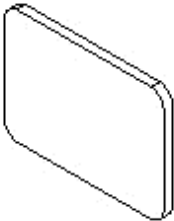
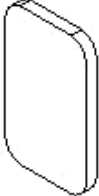
				
AX2_コールボタン	AX2_コントロールボックス	AX2_ジャンクションボックス	AX2_プルボックス	AX2_モニタ付住宅情報盤
				
AX2_レンジファン用埋込コンセント	AX2_ワイド型スイッチ	AX2_ワイド型スイッチ 2連	AX2_分電盤	AX2_埋込コンセント
				
AX2_埋込コンセント 2連	AX2_埋込コンセント 3連	AX2_壁付コンセント	AX2_引掛埋込ローゼット	AX2_弱電機器取付板
				
AX2_感知器	AX2_戸外表示器	AX2_給気ダンパー	AX2_蛍光灯(天井付)	

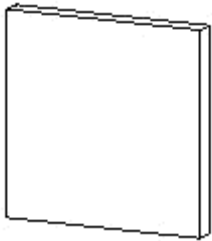
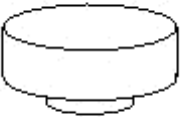
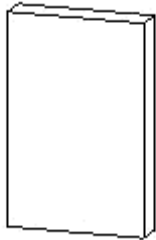
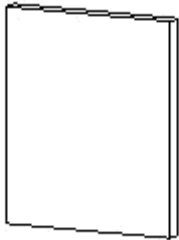
26 設備 > 3D

				
AX_コールボタン	AX_コントロールボックス	AX_ジャンクションボックス	AX_プルボックス	AX_モニタ付住宅情報盤
				
AX_レンジファン用埋込コンセント	AX_ワイド型スイッチ	AX_ワイド型スイッチ 2 連	AX_分電盤	AX_埋込コンセント
				
AX_埋込コンセント 2 連	AX_埋込コンセント 3 連	AX_壁付コンセント	AX_引掛埋込ローゼット	AX_弱電機器取付板
				
AX_感知器	AX_戸外表示器	AX_給気ダンパー	AX_蛍光灯(天井付)	